



Interface Power Hub™

Operator's Manual



Copyright © 2017-2022 Gamry Instruments, Inc.
Revision 6.3
September 19, 2022
988-00028

If You Have Problems

Please visit our service and support page at www.gamry.com/service-support/. This page contains information on installation, software updates, and training. It also contains links to the latest available documentation. If you are unable to locate the information you need from our website, you can contact us via email using the link provided on our website. Alternatively, you can contact us one of the following ways:

Internet	www.gamry.com/service-support/
Telephone	(215) 682-9330 9:00 AM–5:00 PM US Eastern Standard Time (877) 367-4267 Toll-free US & Canada Only

Please have your instrument model and serial numbers available, as well as any applicable software and firmware revisions.

If you have problems in installation or use of a system containing an Interface Power Hub, it would be helpful if you called from a phone next to your computer, where you can type and read the screen while talking to us.

We will be happy to provide a reasonable level of free support for registered users of the Interface Power Hub. Reasonable support includes telephone assistance covering the normal installation, use and simple customization of a computerized system with an Interface Power Hub containing multiple Interface family instruments connected to a Windows®-compatible computer hardware.

A service contract that extends both the hardware warranty and software update period is available at an additional charge. Software updates do not include software enhancements offered to our customers at additional cost.

Enhancements to the Interface Power Hub and Gamry standard applications software that require significant engineering time on our part can be performed on a contract basis. Contact us with your requirements.

Limited Warranty

Gamry Instruments, Inc. warrants to the original user of this product that it shall be free of defects resulting from faulty manufacture of the product or its components for a period of two years from the original shipment date of your purchase.

Gamry Instruments, Inc. makes no warranties regarding either the satisfactory performance of the Interface Power Hub including the software provided with this product or the fitness of the product for any particular purpose. The remedy for breach of this Limited Warranty shall be limited solely to repair or replacement, as determined by Gamry Instruments, Inc., and shall not include other damages.

Gamry Instruments, Inc. reserves the right to make revisions to the system at any time without incurring any obligation to install same on systems previously purchased. All system specifications are subject to change without notice.

There are no warranties which extend beyond the description herein. This warranty is in lieu of, and excludes any and all other warranties or representations, expressed, implied or statutory, including merchantability and fitness, as well as any and all other obligations or liabilities of Gamry Instruments, Inc; including but not limited to, special or consequential damages.

This Limited Warranty gives you specific legal rights and you may have others, which vary from state to state. Some states do not allow for the exclusion of incidental or consequential damages.

No person, firm or corporation is authorized to assume for Gamry Instruments, Inc., any additional obligation or liability not expressly provided herein except in writing duly executed by an officer of Gamry Instruments, Inc.

Disclaimers

Gamry Instruments, Inc. cannot guarantee that the Interface Power Hub will work with all computer systems, operating systems, and third-party software applications hardware/software.

The information in this manual has been carefully checked and is believed to be accurate as of the time of release. However, Gamry Instruments, Inc. assumes no responsibility for errors that might appear.

Copyrights

Interface Power Hub™ Operator's Manual copyright © 2017–2022, Gamry Instruments, Inc., all rights reserved.

Gamry Framework copyright © 1989–2022, Gamry Instruments, Inc., all rights reserved.

Interface Power Hub™, Interface 1010™, Interface 5000™, Reference 620™, Reference 3000™, Reference 3000AE™, Reference 30K™, LPI1010™, eQCM 10M™, ECM8™, Gamry Framework™, Faraday Shield™, and Gamry™ are trademarks of Gamry Instruments, Inc.

Windows® is a registered trademark of Microsoft Corporation.

No part of this document may be copied or reproduced in any form without the prior written consent of Gamry Instruments, Inc.

Table of Contents

If You Have Problems	3
Limited Warranty.....	3
Disclaimers	4
Copyrights	4
Table of Contents.....	5
Chapter 1: Safety Considerations	7
Inspection	7
Product Safety.....	7
Protective Grounding and Product Safety	7
Line Voltage and Fuses.....	8
Replacing or Checking the AC Power Fuses	9
Grounding in the Interface Power Hub.....	10
Temperature and Ventilation.....	10
Defects and Abnormal Stresses	11
Environmental Limits.....	11
Cleaning	12
Service.....	12
RF Warning.....	12
Electrical Transient Sensitivity	12
CE Compliance	13
RoHS Compliance.....	13
Chapter 2: Introduction	15
About this Manual.....	15
About the Interface Power Hub.....	15
USB Hub Characteristics	16
Software and Applications.....	16
Synchronized (Master/Serf) Systems	17
Notational Conventions.....	17
Chapter 3: Installation.....	19
Initial Visual Inspection	19
Physical Location	19
Computer Requirements	20
Quick-Start Guide for Potentiostat and Software Installation.....	20
Software Installation	20
Reboot your Computer after Software Installation	20
AC Power Line Fuses.....	21
AC Power Cord.....	21
Power-Up Test.....	22
USB Cable to the Host Computer.....	22
USB Connections for Multiple IPH Systems	23
IPH Hold-down Mechanism.....	25
Instrument Order in the IPH and Labeling	26
Adding Interface Family Instruments to a New IPH System.....	26
Installing Instrument Power-Supply Cables.....	28
Installing Instrument USB Cables	29
Installing Instrument Cell Cables	29
For Framework Version 6 Users Only: Authorization Codes	29
Cover Plates for Empty Locations.....	30

Table of Contents

Powering Up and Testing the System..... 30

Powering Down an IPH System..... 30

Running Multiple Tests in Parallel..... 31

Removing an Instrument 32

Adding an Instrument to a Running IPH System..... 32

Chapter 4: Panel Indicators, Controls, and Connectors 35

 Front Panel 35

 Power On LED..... 35

 Host Connected LED..... 35

 Rear Panel 35

 Power Switch 35

 Power Input Connector 36

 Host USB Connector..... 36

 Instrument USB Ports 37

 Expansion USB Ports 37

 Instrument Power Connections..... 38

Appendix A: Interface Power Hub Specifications..... 41

 USB Input..... 41

 Instrument USB Ports 41

 Expansion USB Ports 41

 Environmental..... 41

 General..... 41

Appendix B: Certifications..... 43

 Declaration of Conformity: No. DOC-2012-CE-IPH 43

 Certificate of Conformance 44

 Declaration of Conformity: No. DOC-2022-UKCA-IPH 46

Appendix C: Comprehensive Index..... 47

Chapter 1: Safety Considerations

Your Interface Power Hub has been supplied in a safe condition. This chapter of the Interface Power Hub Operator's Manual contains some information and warnings that you must follow to insure continued safe operation of the Interface Power Hub.

Inspection

When you receive your Interface Power Hub you should inspect it for evidence of shipping damage. If any damage is noted, please notify Gamry Instruments Inc. and the shipping carrier immediately. Save the shipping container for possible inspection by the carrier.



Warning: An Interface Power Hub damaged in shipment can be a safety hazard. Do not operate damaged apparatus until a qualified service technician has verified its safety. Tag a damaged Interface Power Hub to indicate that it could be a safety hazard.

Product Safety

The Interface Power Hub has been designed, tested, and certified to meet the requirements of EN 61010, *Safety requirements for electrical equipment for measurement, control, and laboratory use*. As defined IEC Publication 348, *Safety Requirements for Electronic Measuring Apparatus*, the Interface Power Hub is a Class I apparatus with protection against electrical shock obtained by means of a protective earth ground in the apparatus enclosure.

The Interface Power Hub is connected to AC mains power. With proper fusing, it works with AC line voltages from 90 V to 264 V_{AC} at AC frequencies from 47 to 63 Hz, so it should be usable world-wide.

Protective Grounding and Product Safety

A Class I apparatus is only safe from electrical shock hazards if the case of the apparatus is connected to a protective earth ground.

In the Interface Power Hub this protective ground connection is made via the ground prong in the AC line cord. When you use the Interface Power Hub with an approved line cord, the connection to the protective earth ground is automatically made prior to making any power connections. Do not negate the protection of this earth ground by any means. Do not use the Interface Power Hub with a two-wire extension cord, with an adapter that does not provide for protective grounding, or with an electrical outlet that is not properly wired with a protective earth ground.



Warning: If the protective ground is not properly connected, it creates a safety hazard, which could result in personal injury or death.

The IPH is connected to your AC line voltage at the AC Power Input connector. This connector is an IEC 60320 Type C14 male connector, often recognized as the AC line connector for desktop computers.

The Interface Power Hub is supplied with a line cord suitable for use in the United States. In other countries, you may have to replace the line cord with one suitable for your electrical outlet type.

In all cases, you require a line cord terminating in an IEC 60320 C13 female connector.

Only use line cords with an earth ground connection rated to handle at least 1 kW power.



Warning: If you replace the line cord, you must use a line cord with the same polarity and power rating as that supplied with the Interface Power Hub. An improper line cord can create a safety hazard, which could result in personal injury or death.

If you have any doubts about the line cord for use with your Interface Power Hub, please contact a qualified electrician or instrument service technician for assistance. They can perform a simple continuity check to verify the connection of the Interface Power Hub chassis to earth. Note that these checks only verify the safety of your Interface Power Hub AC power connections; they do not verify safety of the system used for a specific application.

Line Voltage and Fuses

The Interface Power Hub can be safely operated at two nominal line-power (mains)voltages: 115 V_{AC} and 240 V_{AC}. Table 1-1 shows the allowed range of input voltage for each nominal line voltage setting. The AC power line (mains) frequency must be between 47 and 63 Hz.

Table 1-1
AC Voltage Ranges for Each Nominal Line Voltage Setting

Nominal Setting	Allowed Range	Fuse Rating	Schurter Time Delay P/N
115	90 to 130 V _{AC}	6.3 A 250 V _{AC}	0034.3125
240	215 to 264 V _{AC}	3.15 A 250 V _{AC}	0034.3122

The instrument automatically switches to use any power-line (mains) voltage in these ranges; however, safe, full power operation in each range requires different AC power-line (mains) fuses as noted above.

The Interface Power Hub depends on fuses in the AC line input to prevent electrical shock and fire hazards in the unlikely case of a catastrophic failure of the power supplies. Two fuses are used, one for each side of the AC line. The Interface Power Hub uses “European Style” 5 mm × 20 mm cylindrical fuses. Time-lag fuses that are designed to meet IEC Publication 60127-2 are required. Schurter FST series fuses are the recommended replacements.

Gamry Instruments has attempted to ship your Interface Power Hub configured for the power-line (mains) voltage in your area. The fuses installed in the Interface Power Hub should be the correct values for the AC line (mains) voltage prevalent in your area. Spare fuses appropriate for your line voltage are also included. If an error was made in the fuse selection, please contact Gamry Instruments or your local sales representative to get the correct fuses.



Warning: You can damage an Interface Power Hub by attempting to operate it with incorrect power line fuses. It is dangerous to plug a unit fused for operation at 100 VAC or 120 VAC into a higher voltage such as 220 VAC. A power-supply fault under these conditions could create a fire or shock hazard.



Caution: Operating an Interface Power Hub with incorrect power line fuses and with high currents drawn from the installed Interface family potentiostats can cause opening of a fuse. You will see this problem when operating the instrument with 115 VAC power and fuses appropriate for 240 VAC operation. Any open fuses must be replaced before the instrument will resume operation.

If you are uncertain which fuses are installed in your Interface Power Hub, check the fuse rating written on the fuses. Step-by-step instructions for checking or hanging the AC line fuses in an Interface Power Hub are shown in the next section of this chapter.

Replacing or Checking the AC Power Fuses

This section of the Interface Power Hub Operator's Manual gives step-by-step instructions for checking or changing the AC power fuses in your Interface Power Hub. Please follow these instructions carefully. You will need a small flat-blade screwdriver to perform this procedure.

- 1) Unplug the AC power cord from the back of the Interface Power Hub. The fuses cannot be changed with the AC line cord plugged into the Interface Power Hub.
- 2) Locate the AC input module on the lower left-hand corner of the Interface Power Hub rear panel. It can be identified by the power-cord connector built into it.
- 3) Find the small slot on the top of the AC input module. Use the blade of a small screwdriver to pry open the door on AC input module.
- 4) The fuses are contained inside a fuse holder. Use the blade of a small screwdriver to pry the fuse-holder out of the AC input module.
- 5) Remove the old fuses by prying them out of the fuse-holders. Replace them with the correct fuses which simply pop into the fuse-holders. The fuse-holder allows for both US and European fuses. The European 5×20 mm fuses supplied with the instrument mount toward the interior end of the fuse-holder. Note that only one end of the fuse clips into the fuse holder: see the photograph in Figure 1-1. The current rating of the fuses is written on the metal ends of the fuse. Make sure that your fuses are the appropriate value for your AC power-line voltage.

Figure 1-1
Fuse-Holder Removed from AC Input Module

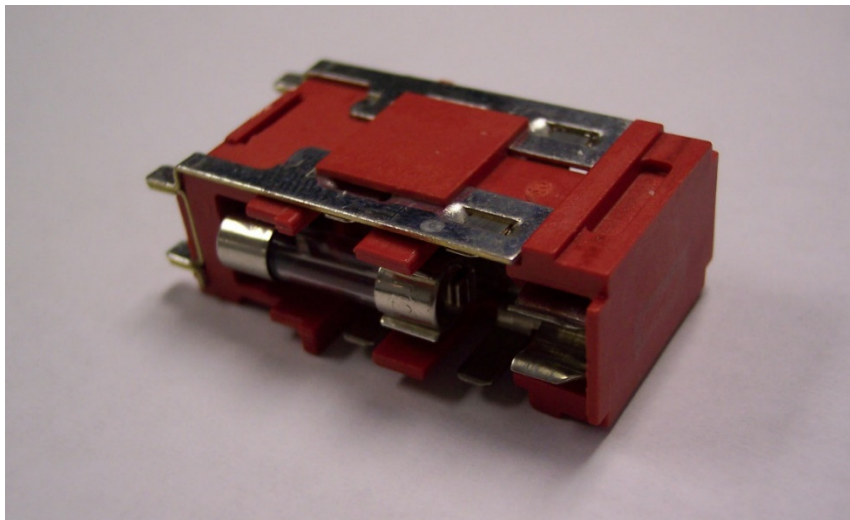

Replace the fuse(s) only with the correct value and type of fuse. See Table 1-1 and the text following it for fuse values and types.

Safety Considerations

- 6) Replace the fuse-holder (with the correct fuses) in the AC input module. **The end with four metal contacts goes into the AC line connector first.** Both orientations that fit work identically.
- 7) Close the cover of the AC input module. It should snap into place.



Caution: The AC power fuses are important components for safe operation of the Interface Power Hub. Do not replace the fuses with incorrect values or types or in any way circumvent the fuse action. If your Interface Power Hub routinely blows the AC line fuses it could indicate a serious problem with the Interface Power Hub. Contact Gamry Instruments or your local sales representative.

Grounding in the Interface Power Hub

The Interface Power Hub is designed for use with two or more Gamry Interface family potentiostats such as the Interface 1010 Potentiostat/Galvanostat/ZRA. There are different grounding considerations for the Interface Power Hub and for the installed Interface family potentiostats.

The circuitry and the metal case of the Interface Power Hub are connected to the protective earth-ground conductor in the AC power cord. This connection gives immunity from electrical shock hazards arising from circuitry faults in the Interface Power Hub.

The **Power** outputs and the Type A USB connectors on the rear panel of the Interface Power Hub are referenced to earth ground.

The Interface family instruments installed in the Interface Power Hub electrically float with respect to earth ground. This allows them to make measurements on electrochemical cells that contain earth-grounded metal. See the relevant Interface family instrument's Operator's Manual for additional information concerning grounding.



Caution: The main isolation of the Interface family potentiostats from the Interface Power Hub chassis is the plastic bezels on both ends of the Interface family potentiostat. Do not install an Interface family potentiostat that does not have these bezels in place.

Temperature and Ventilation

Your Interface Power Hub was designed for indoor use at ambient temperatures between 0°C and 45°C.

The Interface Power Hub uses forced air-cooling to keep the Interface Power Hub components and the installed Interface family instruments within their operating-temperature range. Most of the air needed to cool the Interface Power Hub enters the chassis through two fans on the side of the Interface Power Hub's base. The air flows through the base which contains two large power supplies and the USB hub circuitry, then exits the Interface power hub through the top of the base. The air then flows through any installed Interface family instruments, aided by the fans within the instruments. Finally, the air exits the Interface Power Hub through the holes in its top.



Caution: Do not block the airflow into or out of the Interface Power Hub's chassis. The circuitry of Interface family potentiostats is thermally protected so over-temperature will cause the instrument to shut down. This normally only occurs when the Interface Instrument is operating at or near its full power and airflow through the Interface Power Hub is restricted.

If shutdown occurs during data-acquisition, you may lose experimental data. Running the Interface Power Hub without adequate cooling could also shorten the time to failure of some of the circuitry.

Be careful if you operate the Interface Power Hub in an enclosed space such as a glove-box or NEMA enclosure. The temperature within the enclosure must not exceed 45°C. You may need to provide ventilation holes or even forced air-cooling for the enclosed space if excessive temperature rise occurs.

Defects and Abnormal Stresses

Treat your Interface Power Hub as potentially hazardous if any of the following is true of the unit:

- It shows visible damage,
- It does not operate properly,
- It has been stored for a long period of time under unfavorable conditions,
- It has been dropped or subjected to severe transport stress,
- It has been subjected to environmental stress (corrosive atmosphere, fire, etc.).

Do not use your Interface Power Hub or any other apparatus if you think it could be hazardous. Have it checked by qualified service personnel.

Environmental Limits

There are environmental-limit conditions on the storage, shipping, and operation of this equipment. The Interface Power Hub has **not** been designed for outdoor use.

Storage	Ambient temperature	-40°C to 75°C
	Relative humidity	Maximum 90% non-condensing
Shipping	Same as storage plus	
	Acceleration	Maximum 30 G
Operation	Ambient temperature	0°C to 45°C
	Relative humidity	Maximum 90% non-condensing



Warning: The Interface Power Hub is not designed for operation in conditions where liquid water may enter the chassis, or water vapor may condense within the chassis. Operation of an Interface Power Hub that has water within the chassis can create a safety hazard, which could result in personal injury or death.

Cleaning

Clean the external chassis only when necessary.

Disconnect the Interface Power Hub from all power sources prior to cleaning.

Use a cloth *lightly* dampened with either clean water or water containing a mild detergent to clean the outside of the Interface Power Hub enclosure. Alternatively, you can use isopropyl alcohol.



Caution: Do not use a wet rag or allow fluid to enter the Interface Power Hub enclosure. Do not immerse the Interface Power Hub in any type of cleaning fluid (including water). Do not use any abrasive cleaners.

Service

Your Interface Power Hub has no user-serviceable parts inside. Refer all service to a qualified service technician.



Warning: Never operate the Interface Power Hub with any cover or panel on the chassis open. Dangerous voltages are present at several points within the Interface Power Hub chassis, including PC board traces. Always remove the power connection before opening the Interface Power Hub's case.

RF Warning

The Interface Power Hub has been tested for both radiated and conducted RF interference and for immunity to RF fields and found to be in compliance with FCC Part 18 and EN 61326:1998—*Electrical equipment for measurement, control, and laboratory use—EMC Requirements*.

However, your Interface Power Hub Potentiostat/Galvanostat/ZRA does still generate some radio frequency energy. The radiated levels are low enough that the Interface Power Hub should not create an interference problem in most industrial laboratory environments.

Your Interface Power Hub can also respond to environmental radio-frequency energy. We recommend you avoid using cell phones and other radio-frequency equipment in the same room as an Interface Power Hub. The Interface Power Hub circuitry has been tested for operation in high-intensity RF fields and has demonstrated little response to those fields. However, there is no guarantee that the electrochemical cell and its connections will not respond to RF fields. This response most often appears as DC shifts in a cell's response because of rectification of the RF signal.

A Faraday cage surrounding your cell can be used to minimize the effect of environmental RF fields. If your cell is isolated from earth ground, Gamry recommends connecting your Interface Power Hub to earth ground and then connecting the Faraday cage to the Interface Power Hub's floating ground (the black lead on the cell cable).

Electrical Transient Sensitivity

Your Interface Power Hub was designed to offer reasonable immunity from electrical transients, including transients on the incoming AC Mains supply and Electrostatic Discharge. It has been tested for compliance with EN 61326:1998—*Electrical equipment for measurement, control, and laboratory use—EMC Requirements*

Safety Considerations

describing acceptable limits for Electrical Transient susceptibility in Laboratory Test equipment. It should continue to operate when subject to the standard ESD and power-line events defined in EN 61326.

In severe cases involving transients beyond the limits tested in EN 61326, the Interface Power Hub could still malfunction as a result of electrical transients. If you are having problems in this regard, the following steps may help:

If the problem is static electricity (sparks are apparent when you touch the Interface Power Hub or its cables):

- Placing your Interface Power Hub on a static control work surface may help. Static-control work surfaces are now generally available from computer supply houses and electronics tool suppliers. An antistatic floor mat may also help, particularly if a carpet is involved in generating the static electricity.
- Air ionizers or even simple air humidifiers can reduce the voltage available in static discharges.

If the problem is AC-line transients (often from large electrical motors near the Interface Power Hub):

- Try plugging your Interface Power Hub into a different AC-power branch circuit.
- Plug your Reference family potentiostat into a power-line surge suppressor. Inexpensive surge suppressors are now generally available because of their use with computer equipment.

Contact Gamry Instruments, Inc. if these measures do not solve the problem.

CE Compliance

The European Community has instituted standards limiting radio-frequency interference emitted by electronic devices, setting limits for susceptibility of apparatus to RF energy and transient events, and mandating safety requirements. Gamry Instruments, Inc. has designed and tested the Interface Power Hub to comply with these standards.

The relevant CE regulations include EN 61010 and EN 61326.

RoHS Compliance

The Interface Power Hub has been built using lead-free components and lead-free solder. It is in compliance with the European RoHS initiative.

Chapter 2: Introduction

About this Manual

This manual covers the installation, safety, and use of the Gamry Instruments Interface Power Hub (IPH). It assumes the IPH is used with Gamry Interface family potentiostats. The IPH should also be compatible with future Interface family devices.

This manual describes use of an IPH with Revision 7 (and later revisions) of the Gamry Framework software.

Chapter 1 was an in-depth discussion of safety issues. This chapter describes this manual and gives a brief overview of the IPH features. Chapter 3 contains Interface Power Hub installation instructions. Chapter 4 is a description of the external controls, connectors, and indicators in the IPH.

About the Interface Power Hub

The Interface Power Hub is a convenient tool for organizing electrochemical test systems that contain multiple Gamry Interface Family Potentiostat/Galvanostat/ZRAs. Its functions include:

- Keeping the potentiostats in a specific order,
- Allowing for easy transportation of the entire system within a facility,
- Providing DC power for the Interface family devices,
- Simplifying USB connections for all the potentiostats in the system, and
- Providing air-flow to keep the instruments cool

A test system *without* an IPH built around a laptop computer and eight independent Interface family potentiostats needs a minimum of:

10	AC power outlets
10	AC power cords
10	AC-DC power bricks
10	USB cables
1	USB Hub

This system contains 31 (or more) cables, some of which are inevitably too long. All these cables typically end up tangled into a “rat’s nest.” Removing one potentiostat from the system requires unraveling the rat’s nest, which will often unplug more than one instrument.

The same system *with* an IPH requires:

2	AC Power outlets
2	AC Power cords
1	Long USB cable
8	Short USB cables
8	Short DC power cables

The short USB and DC Power cables provided with the IPH are just long enough for point-to-point wiring. They are too short to get tangled into a “rat’s nest.” The system is simpler and easier to maintain.

The IPH simplifies movement of an electrochemistry system within a facility. You can usually move an IPH system without disconnecting the USB and power connections to its instruments. You only need to disconnect its AC power cord and host USB connection. As a result, moving an 8-instrument IPH system typically takes a couple of minutes, in contrast to the half hour or more often required to move the same system without an IPH.

The Interface family potentiostats within the IPH are isolated from earth ground and from each other. They can be used to make measurements on cells that contain an earth grounded metal. A few of the many

examples of such cells are autoclaves, large metal storage tanks, stress apparatus, and capillary electrophoresis detectors.

USB Hub Characteristics

Among other IPH features, the IPH is a fully functional 10-port High Speed USB hub. It is compatible with Revision 2.0 of the USB specification. It is a generic Windows®-compatible 10-port hub, so it does not require any specific driver software.

Eight of the downstream **USB** ports on the IPH are normally used to connect Interface family instruments to the system. They are labeled as USB1, USB2, USB3..., USB8.

The other two USB downstream ports are labeled **Expansion USB** ports. They can be used to connect other IPHs, to connect a software key, or to connect third-party USB devices, such as a USB flash drive.



Caution: Gamry Instruments, Inc. is not responsible for system failures or system slowdowns caused by third-party devices plugged into the IPH's **Expansion USB** ports. Very high-bandwidth USB transfers employing one of the expansion ports can be a problem.

The **Expansion USB** ports do not support battery charging through USB power. We do not recommend connection of cell phones, MP3 players, or tablet computers to these ports.



Caution: The total current drawn from all ten USB ports must be less than 500 mA. Interface Family instruments typically requires less than 10 mA, so the total current drawn by the Expansion ports must be less than 420 mA. Excess current will trip a resettable fuse, which can cause loss of data if the system is acquiring data.

Software and Applications

The IPH functions as a Windows®-compatible USB hub, which makes it transparent to applications software. As a result, an IPH system operates with all applications software supported by its Interface family potentiostats.

The Interface Power Hub is particularly useful in laboratories where high test-throughput is required. All the IPH potentiostats, or a group of instruments, can run the same test in parallel when this is required.

The IPH also offers flexibility: Each instrument in the system can simultaneously run dissimilar tests, each started and stopped at different times.

A potentiostat can be removed or added to a working IPH system. The other potentiostats can continue to run tests while this change is made.

Typical applications for the Interface Power Hub include:

- Corrosion testing,
- Evaluation of protective coatings and paints,
- Research in electrochemical storage and conversion,
- Battery and electrochemical capacitor evaluation,
- Bio-electrochemical testing,

- Electrochemical sensor development.

Synchronized (Master/Serf) Systems

In some multiple potentiostat systems, users want synchronized operation of several potentiostats. This is often desirable when multiple units are connected to one electrochemical cell. Examples of this include ring-disk systems, series-connected laminar flow generation-detection systems, localized EIS, and electrochemical microscopy.

A special synchronization port (**Sync** port) on the rear of each Interface family potentiostat allows one master instrument to control the clocks and data acquisition timing of multiple serf instruments. The master can even generate sine waves used for EIS experiments and the serfs can acquire very accurate EIS data derived from the master's excitation waveform.

Notational Conventions

In order to make this manual more readable we have adopted some notational conventions. These are used throughout this manual and all other Gamry Instruments manuals:

- Numbered lists. A numbered list is reserved for step-by-step procedures, with the steps always performed sequentially.
- Bulleted list: The items in a bulleted list, such as this one, are grouped together because they represent similar items. The order of items in the list is not critical.
- Menu commands. Menu commands are shown in Boldface, with commas separating menu levels: i.e., **Utilities > Instrument Manager** which is the Instrument manager found on the Gamry Framework Utilities Menu.
- File names and folders. Inside paragraphs, references to computer files and Windows® folders are capitalized and placed within quotes, for example: "C:\MYGAMRYDATA\CV.DTA" and "GAMRY.INI".

Chapter 3: Installation

This chapter of the Gamry Instruments Inc. Interface Power Hub Operator's Manual covers normal installation of the Interface Power Hub. We assume the Interface Power Hub (IPH) is installed as part of a Gamry Framework-based electrochemical measurement system containing a Microsoft Windows®-compatible computer.

Figure 3-1
Front View of an Interface Power Hub



Initial Visual Inspection

After you remove your IPH from its shipping carton, check it for any signs of shipping damage. If any damage is noted, please notify Gamry Instruments, Inc. and the shipping carrier immediately. Save the shipping container for possible inspection by the carrier.



Warning: If the Interface Power Hub is taken from a cold location (for example, outdoors in winter conditions) to a warm humid location, water vapor could condense on the cold surfaces inside the Interface Power Hub, possibly creating a hazardous condition. Before connecting AC power to a “cold” Interface Power Hub, allow at least one hour for the Interface Power Hub to warm at room temperature.

Physical Location

In general, place your Interface Power Hub on a flat workbench surface. You need to have access to the rear of the instrument, for some cable connections are made from the rear. The Interface Power Hub is usually

operated in the position shown in Figure 3-1. The IPH requires a minimum of 4 cm of unobstructed airspace on both sides and above the chassis.



Caution: Do not block the airflow into or out of the Interface Power Hub. The Interface family devices within the IPH could overheat if IPH airflow is impeded.

If you place your IPH within an enclosed space, make sure that the internal temperature within that space does not exceed the IPH's 45°C ambient temperature limit. Be particularly careful if a computer or other heat-dissipating equipment is mounted in the same enclosure as the IPH.

The IPH has not been designed for outdoor use.

Computer Requirements

Before you connect an Interface Power Hub to a computer you must make sure that your computer meets these simple requirements.

- A computer based on one of the x86 family of Intel™ microprocessors or a 100%-compatible processor from another vendor.
- Microsoft Windows® 10 or newer is required with Gamry Framework™ software version 7.9.1 and above. Only the 64-bit version of these operating systems is supported.
- A USB port that supports Full-Speed (12 Mbits/second) or High-Speed (480 Mbits/second) USB transfers. It must be compatible with Revision 1.1 or Revision 2.0 of the USB specification.

Quick-Start Guide for Potentiostat and Software Installation

Your shipment should have included a short document entitled **Quick-Start Guide: USB Potentiostat Installation**. It contains the latest instructions for installing Gamry Instruments hardware and software onto a computer system. The software installation information in this document is particularly useful in the installation of an IPH system. The hardware installation portion is superseded by the hardware installation instructions below.

Software Installation

Follow the software instructions in the **Quick Start Guide: USB Potentiostat Installation**.

Reboot your Computer after Software Installation

Reboot your computer after the Gamry Setup program is done. The Setup program normally offers you the opportunity to do so. USB device-drivers are usually loaded when Windows® boots up. Following Setup, you may not be able to use the potentiostats in your Interface Power Hub until the drivers are loaded.



Device Driver Installation may not occur until a while after the Windows® Desktop appears. On a slow computer, or a busy computer with lots of applications, the delay before driver installation can be a minute or more.

AC Power Line Fuses

The IPH is powered from an AC power source. The power input frequency must be between 47 and 63 Hz. The input voltage has two allowed ranges: between 90 and 130 V_{AC} and between 215 and 264 V_{AC}.

Different input fuses are required for each of these ranges.

Gamry Instruments ships your Interface Power Hub configured for the power line (mains) voltage in your area. Therefore, the fuses installed in the Interface Power Hub should be the correct values for your AC line voltage. Spare fuses appropriate for your line (mains) voltage are also included. If an error was made in the fuse selection, please contact Gamry Instruments or your local sales representative to get the correct fuses.

Never operate an IPH with incorrect fuses!



Warning: You can damage an Interface Power Hub by attempting to operate it with incorrect power-line (mains) fuses. It is dangerous to plug a unit fused for operation at 100 VAC or 120 VAC into a higher voltage such as 220 VAC. A power-supply fault under these conditions could create a fire or shock hazard.



Caution: Operating an Interface Power Hub with incorrect power-line fuses and with high currents drawn from the installed Interface family potentiostats can cause opening of a fuse. This problem appears when you operate the instrument with 115 VAC power and fuses appropriate for 240 VAC operation. Any open fuses **must be replaced** before the instrument will resume operation.

Chapter 1 of this manual includes instructions for checking and/or changing the AC fuses.

AC Power Cord

The Interface Power Hub external supply is normally supplied with a line cord suitable for use in the United States. In other countries, you may have to replace the line cord with one suitable for your type of electrical outlet.

You must always use a line cord with an IEC 60320 C13 female connector on the apparatus end of the cable. This is the same connector used on the US standard line cord supplied with your Interface Power Hub. The line cord should be similar to those traditionally supplied with desktop computers.

Figure 3-2
Rear View of an Interface Power Hub

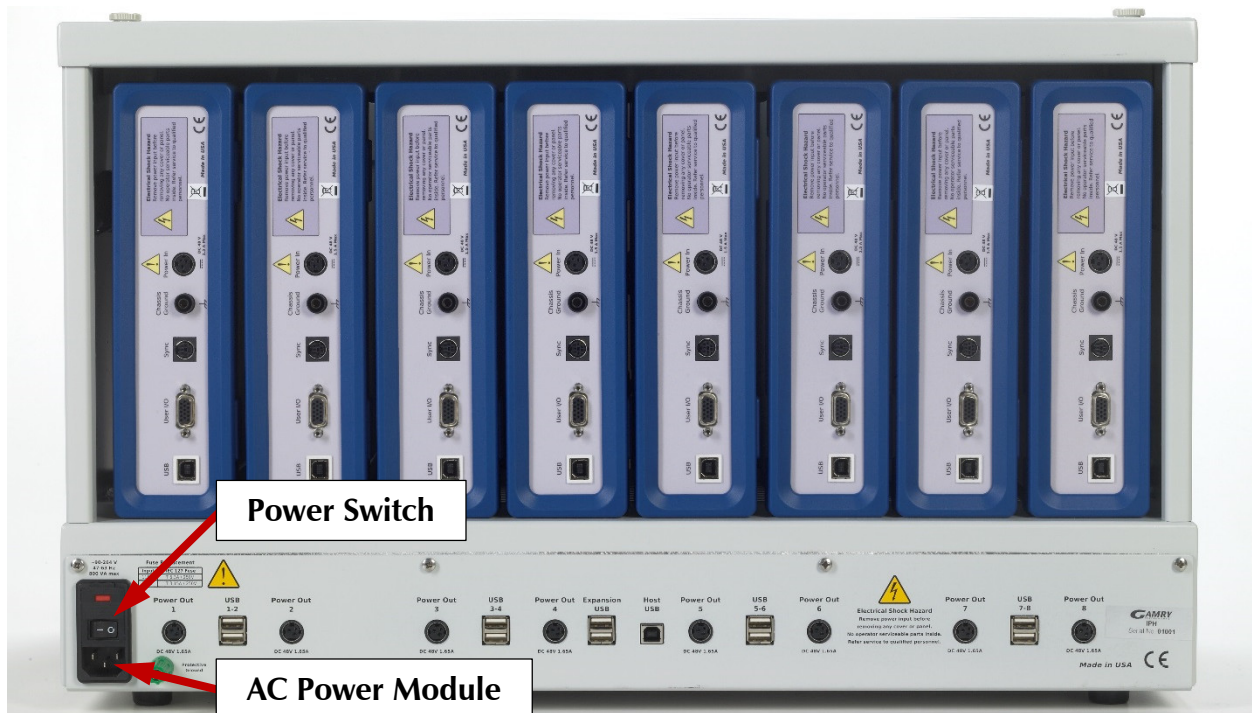

The power cord plugs into the AC Power Module on the back of the IPH.

Power-Up Test

Before you make any other connections to your Interface Power Hub you should check that the power supplies in the IPH are nominally functional by following these steps:

1. Connect AC (mains) power to the Interface Power Hub.
2. Turn on the power switch in the Input Power Module on the rear panel of the IPH (see Figure 3-2). It is found just above the power cord.
3. The **Power On** LED on the IPH front panel illuminates.
4. Both fans (one on each side) on the IPH rotate.
5. Turn off the unit if Steps 3 and 4 are successful.

USB Cable to the Host Computer

The Interface Power Hub connects to the computer using a 1.8-m, filtered High-Speed USB A/B cable, shipped with your Interface Power Hub. The replacement cable is Gamry Instruments part number 985-00131.

An A/B USB cable has different connectors on each end. The end with a wider, rectangular “Type A” connector plugs into a USB port on your computer (or a similar port on a USB hub). The end with a nearly square “Type B” connector plugs into the **Host USB** port on the Interface Power Hub.

Installation



The USB connection can be “hot-plugged”. This means both the computer and the Interface Power Hub can be powered-up before the USB cable is plugged in.

You can also safely remove the Host USB cable without powering down the Interface Power Hub and your computer. Be aware, however, that this may have undesirable consequences if the system is currently taking data or performing an electrochemical experiment.

USB Connections for Multiple IPH Systems

The IPH is a 10-port USB hub. Gamry Instruments Interface family potentiostats connect to USB ports 1–8.

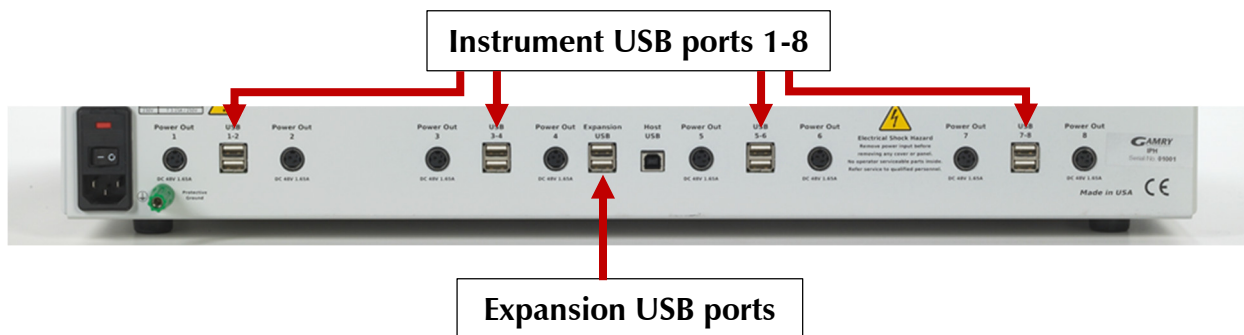

The IPH also has two **Expansion USB** ports.

These ports are intended for connection of additional IPHs (as described below) or used to connect USB keys. They are not restricted to these functions. Use of these ports for high-bandwidth data-transfers (such playing a movie on an iPod) is **not recommended** during system operation.

Gamry Instruments’ current Framework software (Revision 7) allows a computer to operate up to 16 Gamry Instruments potentiostats simultaneously. The 16 potentiostats can include single Interface family instruments, instruments in IPHs, and Gamry Instruments’ Reference family instruments.

When you make any USB connections, make sure you do not have too many series-connected USB Hubs. You are only allowed 5 hubs in series. The IPH counts as **two** series-connected hubs.



Revision 2.0 of the USB Specification limits the number of “connection tiers” to 7. The first connection tier is the root hub inside the host computer. The 7th connection tier can only contain functional devices; hubs are not valid on this tier. Hubs are allowed on tiers 2 through 6. You are therefore limited to five hubs connected in series.

An IPH is functionally two hubs connected in series, so it uses two connection tiers. Two IPHs connected in series uses four connection tiers. **You cannot connect the USB ports of three IPHs in series, because this requires six connection tiers, and only five connection tiers can contain hubs.**

A system with multiple IPHs can use several different USB connection schemes.

- Each IPH can connect directly to a USB port on the computer. See Figure 3-3:

Figure 3-3
First Connection Scheme for a Multiple IPH System

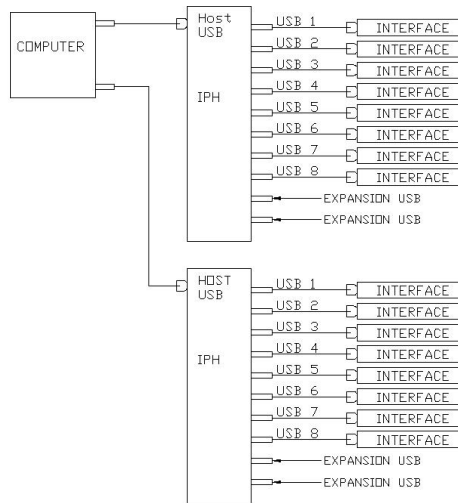

- Each IPH can connect to the output ports of a third-party USB hub port. The third-party USB hub connects to your computer's USB port. See Figure 3-4. The third-party hub must be USB 2.0 High-Speed compliant.

Figure 3-4
Second Connection Scheme for a Multiple IPH System

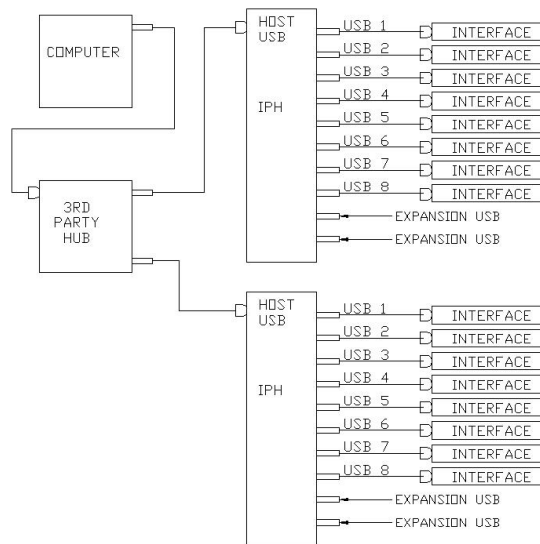

- IPHs can be connected in series. One IPH connects to a computer, and other IPHs connect to the Expansion USB ports on the first IPH. See Figure 3-5.

Figure 3-5
Third Connection Scheme for a Multiple IPH System

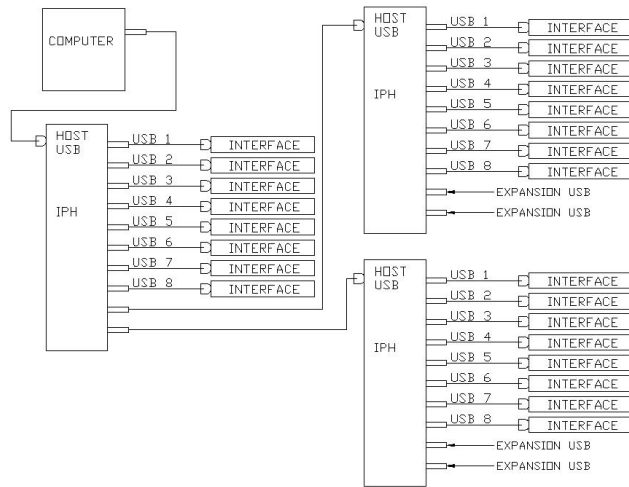

Figure 3-5 shows connections to 24 Interface Instruments. This is more than the current Framework software's limitation of 16 instruments. Several of the three IPHs in this configuration must have fewer than eight instruments connected and powered up.

IPH Hold-down Mechanism

A Hold-down mechanism on the top of the IPH chassis clamps Interface family instruments within the IPH chassis. Two large knurled knobs (the Hold-down Knobs) on the top of the chassis are used to raise and lower the Hold-down bar that keeps the instruments in place.



Instruments are securely held in place when the bar is lowered. The bar must be raised when you want to add or remove instruments.

Rotate the knobs using finger-pressure **only**. Use of tools to rotate the knobs can cause mechanical damage to the IPH.



Caution: Never use tools to turn the IPH Hold-down Knobs. Finger-pressure should be sufficient to rotate the knobs. Use of tools on the knobs can void the IPH warranty.

Rotate both knobs in the same direction to either raise or lower the bar. You do not need to rotate both knobs at the same time. However, we do not recommend rotation of one knob by more than five turns without rotating the other knob.

Clockwise rotation of the knobs on the top panel raises the hold-down bar. This unclamps instruments previously installed in the system and allows addition or removal of instruments.

Counter-clockwise (or anti-clockwise) rotation lowers the hold-down bar. This clamps the instruments into the IPH.

Instrument Order in the IPH and Labeling

In many labs, the instruments in an IPH are left in place for a long time. When this is the case, re-label the instruments prior to placing them in the IPH chassis. This makes instrument selection easy.

Interface 1010 potentiostats have a “Personalization Area” on the front panel that can be used for labeling. Each instrument comes with a label sheet containing labels useful in configuring an IPH system. Sequence labels on this sheet, such as Pstat 1, Pstat2, Pstat3, ... Pstat16 make for very easy potentiostat identification. Consult the Interface 1010 Operator’s Manual for detailed instructions describing how to change a label. A PDF of this manual can be found on Gamry’s website or on the software-distribution device supplied with your system.

If you do re-label the instruments, make sure that you enter the new labels in the Gamry Instrument Manager (GIM). The Instrument Manager can also be used to change the order of instruments in experiment **Setup** dialog boxes. Find the **Instrument Manager** in the Framework’s **Options** menu.

Regardless of the instrument labels, it is generally a good idea to place instruments in the IHP in a specific order. When multiple potentiostats are purchased on one purchase order, Gamry usually ships instruments with sequential serial numbers. This can be useful in ordering instruments that have not had label changes.

At Gamry Instruments, we usually install instruments in an IPH starting on the left side on the chassis, viewed from the front. The instrument with the lowest label (lowest serial number or PStat1) is installed first. The instrument with the next lowest label goes on its right and this order continues for all the installed instruments. You can follow Gamry Instruments’ layout or choose your own arrangement.

Adding Interface Family Instruments to a New IPH System

Generally, you power off your IPH and make a Host USB connection before adding Interface family instruments.

Instruments must be added from the front of the chassis. You also need to access the rear of the IPH to make cable connections. Follow these step-by-step instructions to add Interface Instruments to an empty IPH:

1. Rotate the Hold-Down Knobs fully clockwise. This raises the Hold-down Bar.
2. Select the first instrument to be installed. Rotate the instrument from its normal horizontal position to a vertical position. When the instrument is oriented properly, the Gamry logo and the power switch are toward the bottom of the instrument.
3. Tilt the instrument so the top rear of the instrument enters the chassis first. See Figure 3-6.

Installation

Figure 3-6
Tilting the Instrument to Place it in the IPH Chassis



4. Undo the tilt to get the instrument horizontal again. The instrument's rear bezel should be inside the IPH chassis. You may need to lift the whole instrument slightly so that its rear bezel clears the plastic front positioning bar on the bottom of the IPH chassis. See Figure 3-7.

Figure 3-7
Ready to Slide Instrument into the IPH Chassis

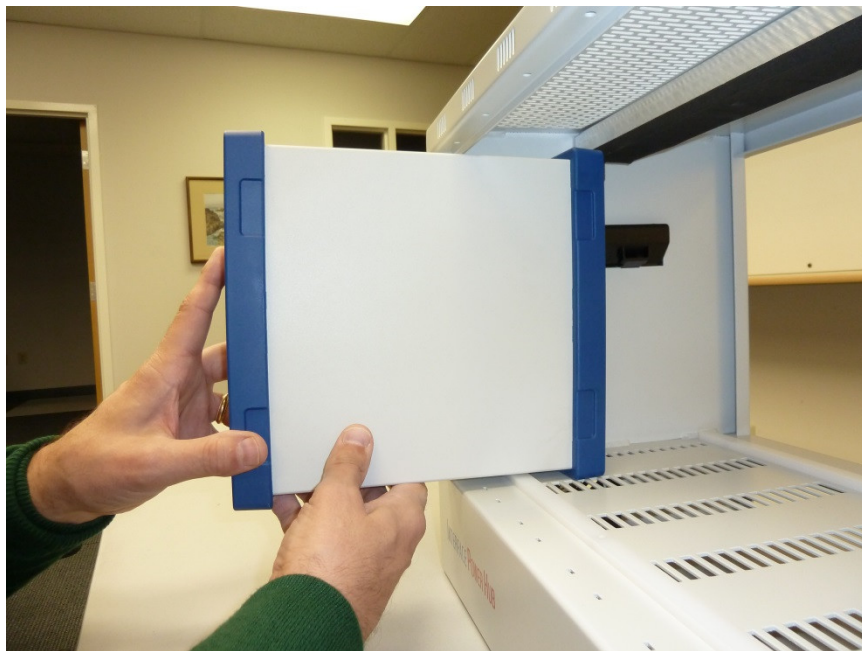

5. Slide the instrument into the IPH chassis. It will slide until the rear bezel hits the plastic rear positioning bar in the IPH chassis.
6. Holding the front of the instrument, tilt it so the rear bezel clears the rear positioning bar. See Figure 3-8.

Figure 3-8
Tilt Instrument to Clear Rear Positioning Bar

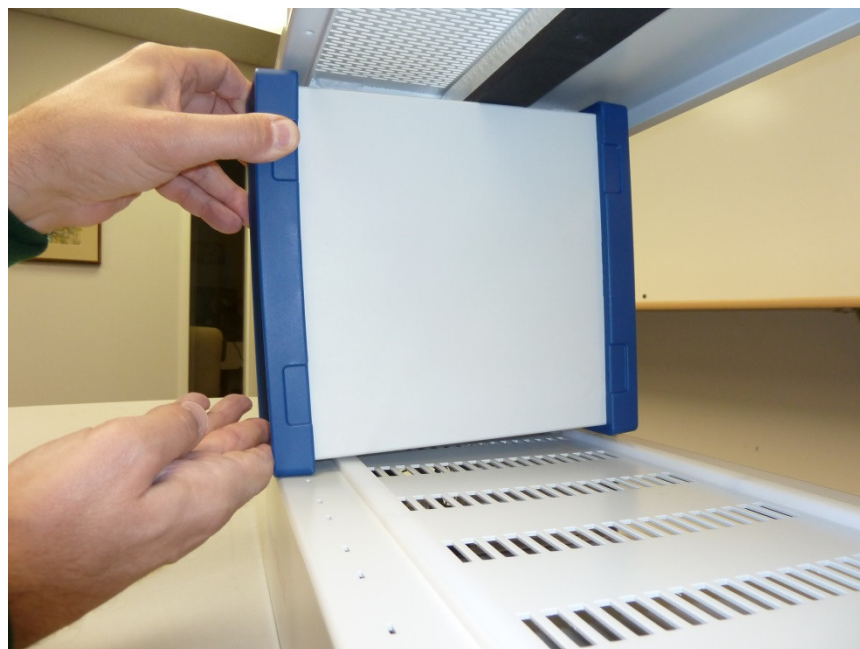

7. Slide the tilted instrument until the front bezel hits the front positioning bar. The instrument's front panel should be about 1.5 cm behind the front panel of the IPH.
8. Return the instrument to a horizontal position. When the instrument is properly positioned, it cannot be slid forward or backward in the chassis without lifting it over a positioning bar.
9. Slide the instrument left or right to the desired location in the chassis—do not move the instrument forward or back. At Gamry Instruments, we generally fill an IPH starting with the left-most chassis location. Each instrument should cover two slits in the chassis just in front of the front hold-down bar. These slips can hold a Cover Plate on an open location.
10. Repeat Steps 2 through 9 for the other instruments in the system.
11. When all the instruments are positioned properly, turn the Hold-down knobs counter-clockwise until they become hard to turn. Do not use tools; finger-tight is sufficient.
12. Confirm that the instruments are held firmly in place.

Installing Instrument Power-Supply Cables

The IPH has eight **Power Out** ports that provide +48 V DC power suitable for powering an Interface Family potentiostat

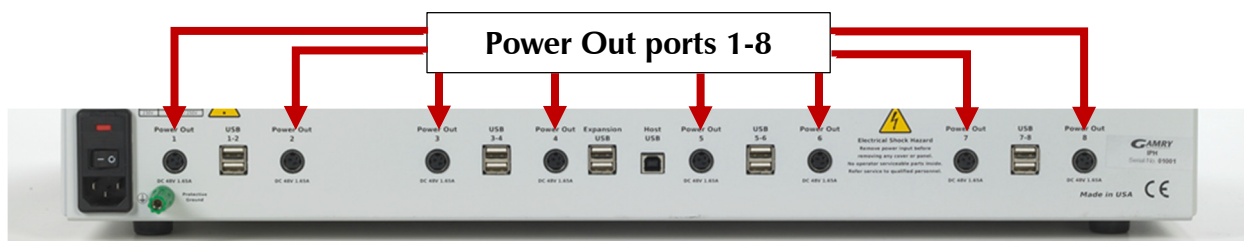

The IPH provides enough power to allow all eight Interface Instruments to operate at their full compliance current.

The DC power bricks normally used to power Interface Family potentiostats are not used in an IPH system.

Each instrument in the IPH is powered using a short power cable, only 35 cm long. The cables have an identical 3-pin power DIN connector on each end. Each cable connects from a numbered IPH **Power Out** port to the **Power In** port on the instrument. The two ends of the cable are interchangeable.

Each instrument connects to the **Power Out** port immediately below it. The numbers on the ports are unimportant except when reporting failures. The cables are short enough that it is difficult to improperly connect them.

The power cables can be connected with the IPH power switch and the potentiostat power switches in the ON or OFF position. If both are ON, the instrument will power up when the connection is made. The cell switch on a newly powered instrument is always open.

Replacement IPH power cables are Gamry Instruments part number 985-00130. An IPH USB cable and an IPH power cable can be ordered together as Gamry Instruments part number 990-00301.

Installing Instrument USB Cables

There are eight numbered **USB** Ports on the back of the IPH. They are implemented with dual USB connectors. You can connect any instrument to either an upper or lower **USB** port.



Each instrument in the IPH is connected to a **USB** port using a short USB cable. The cables are only 23 cm long. The nearly square end of the cable connects to the instrument's USB port. The more rectangular end of the cable connects to one of the numbered **USB** ports on the IPH.

Each instrument connects to the one of the pair of **USB** ports immediately below it. The numbers on the ports are unimportant except when reporting failures. The cables are short enough that it is difficult to improperly connect them.

USB connections can be 'hot plugged.' This means they can be connected to a powered Interface family instrument and a powered host computer.

Replacement IPH USB cables are Gamry Instruments Part Number 985-00129. An IPH USB cable and an IPH power cable can be ordered together as Gamry Instruments Part Number 990-00301.

Installing Instrument Cell Cables

Each Interface family instrument in the system needs cell connections. Details of the cell connections vary from instrument to instrument. Connect the cell cables as described in each instrument's Operator's Manual.

For Framework Version 6 Users Only: Authorization Codes

You will need Authorization Codes in version 6 to run Gamry's software on the Interface Instruments in an IPH.

Individual Interface Instruments can have their own Authorization codes. These will have been provided with the initial purchase of a software license for a specific instrument and a specific software application package. The authorization codes for an instrument can be loaded onto multiple computers which makes movement of instruments very easy.

Gamry Instruments' MultEChem systems usually include one or more USB dongles that authorize software for multiple instruments. Each dongle only requires one Authorization code. The USB dongle must be plugged into a USB port on the same computer as the instruments it authorizes. The **Expansion USB** ports are a convenient location for the dongle. Only plug one USB dongle into the IPH or computer at a time.

The system requires knowledge of the Dongle's or the instrument's Authorization codes before they can be used. Authorization codes can be entered by selecting **Options, Instrument Manager...** on the Gamry Framework's menu.

Cover Plates for Empty Locations

Gamry offers IPH Cover Plates that can be used to make a partially-filled IPH look more “finished”. One Cover Plate fills the hole left by one missing Interface Family instrument. It snaps into place.

IPH Cover Plates are not provided with an IPH system. They are available for sale. The part number for a single IPH Cover Plate is 990-00298.

Powering Up and Testing the System

An IPH system is powered by turning on the IPH's rear-panel power switch and the power switches for all the Interface Family instruments in the system.



When the IPH's power is ON, its front-panel **Power On** LED should illuminate.

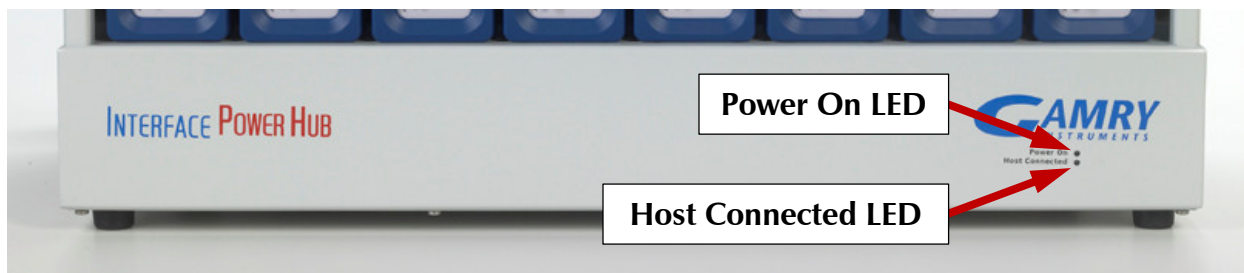

When the IPH has power and the power switch for an Interface Family instrument is turned ON, the blue **Power** LED for that instrument should blink for a few seconds, then change to a steady blue. If the host computer is connected and powered up, the **Host Connected** LED on the IPH front panel should glow yellow.

Identification of all the potentiostats in an IPH by the Windows® Device Manger and Framework software will take a while. Allow at least one minute for all IPH potentiostats to appear in Gamry Instruments' Framework software.

Because IPH systems can be used for a large number of electrochemical tests, Gamry cannot provide a simple and comprehensive checkout procedure for all systems.

Instrument calibration is one universal utility that can be run on all Interface family Instruments. Each potentiostat must be calibrated separately by selecting **Experiment > Utilities > Calibrate** in the Framework menu. While each calibration must be started separately, the calibrations for all instruments can be run simultaneously.

Powering Down an IPH System

Individual instruments in the system can be powered down using the front-panel **Power** switches on the Interface potentiostats.

If the entire system will be powered down, turn off the rear-panel power switch on the IPH. If the instrument power switches are left on, the entire system will power up when the IPH power switch is turned on.

Running Multiple Tests in Parallel

Gamry Instruments' Framework software, Revision 7 and higher, includes method for running simultaneously running identical tests on multiple potentiostats. All the tests that are run simultaneously must use the same technique and use identical Setup parameters.

The tests are running using the Framework's Sequence Wizard. The next two figures show the process used to run multiple simultaneous Potentiostatic EIS tests.

Open the Framework's Sequence Wizard by selecting **Experiment > Sequence Wizard**. Generate a sequence like that in the next figure.

Figure 3-9
Simple Sequence for Simultaneous EIS

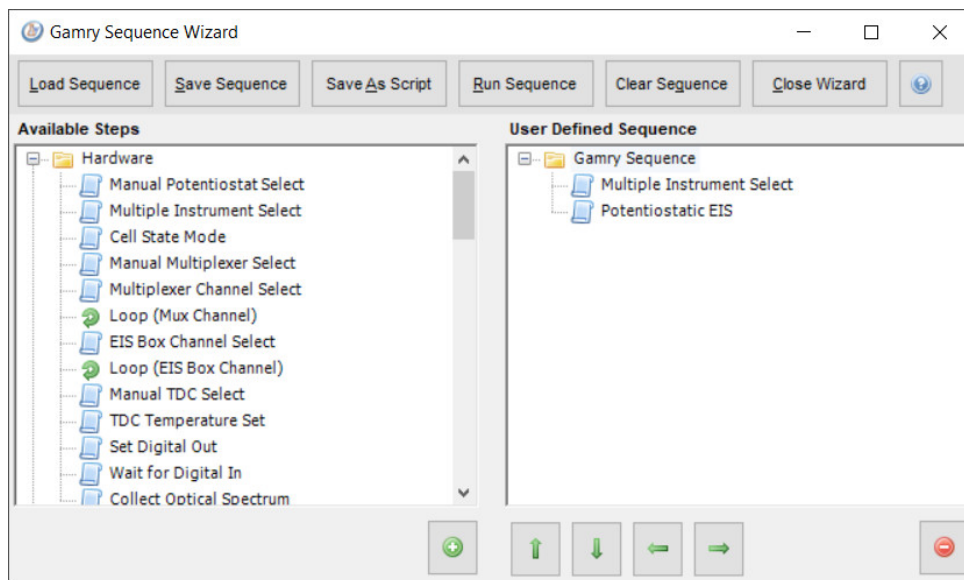

Double-click on the Potentiostatic EIS Step to select the EIS Setup parameters that will be used to run the tests. Make sure you choose a unique Base filename. The data file for each test will either be:

- stored in a subfolder of My Gamry data under this name, or
- given a name that includes this Base Filename and the Potentiostat name.

When you run the sequence, the Multiple Potentiostat Select step displays a dialog box like that in the next figure:

Figure 3-10
Run Time Dialog for Multiple Instrument Select

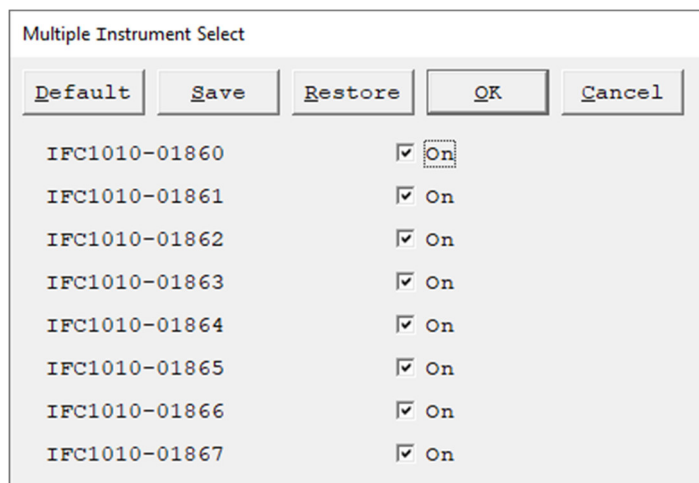

The test will be run on all the potentiostats marked with a check (tick).

Removing an Instrument

An instrument can be removed from an IPH even when other potentiostats are running tests. Instruments are removed from the front of the chassis. You also need access to the rear of the IPH to remove cable connections.

The instrument to be removed must be powered down and disconnected before it is physically moved. **Be careful to choose the correct instrument!** Removing the connections from a potentiostat that is running a test causes loss of data.

Follow these steps to remove an instrument from an IPH:

1. Turn off the power switch on the instrument to be removed.
2. Note the instrument's position in the IPH. Remember that an instrument on the left side when viewed from the front of the IPH will be on the right side when viewed from the rear of the IPH.
3. From the rear of the IPH, unplug the Power and USB cables connecting the IPH to the instrument to be removed. Do not accidentally remove cables to other instruments.
4. Turn the Hold-down Knobs fully clockwise to raise the IPH's Hold-down bar.
5. Carefully reverse the procedure illustrated in Figure 3-6 to Figure 3-8 to remove the instrument. If other instruments are running tests, leave a gap in the array of instruments; do not slide the remaining instruments over to fill the gap.
6. After the instrument is fully removed, turn the Hold-Down knob counter-clockwise to clamp the remaining instruments in the IPH.

The Framework software will re-order the remaining instruments, skipping the instrument that has been removed. If Pstat 2 of a normally organized four-potentiostat system is removed, Framework Setup dialog boxes will show Pstat 1, Pstat 3, and Pstat 4 in that order.

Adding an Instrument to a Running IPH System

An instrument can be added to an IPH (with one or more empty instrument locations) even when other instruments are running tests. Instruments must be added from the front of the chassis. You also need access to the rear of the IPH to make cable connections.

The instrument can be added to any open location in the IPH chassis.

Installation

To add the instrument, follow these steps:

1. Choose an empty location where the instrument can be added. An instrument can be added to an empty location in the middle of an array of instruments.
2. Turn the IPH Hold-down Knobs fully clockwise to raise the IPH's Hold-down bar.
3. If the instrument is filling a gap in an array of numbered instruments, you may want to change the label in the new instrument's Personalization Area. If the gap is surrounded by instruments labeled PStat 1, PStat3, and PStat 4, the label of the added instrument should be changed to PStat 2.
4. Carefully follow the procedure illustrated in Figure 3-6 to Figure 3-8 to physically add the instrument.
5. Once the instrument is added, turn the Hold-Down knob counter-clockwise to clamp the remaining instruments in the IPH.
6. From the rear of the IPH chassis, connect the power and USB cables from the IPH to the new instrument. Make sure you do not accidentally remove any of the existing cables.
7. When a new instrument is powered up and identified by the Gamry Framework, it normally appears last in the list of available instruments. If it is being used to fill a gap in an array of instruments, run the Framework's Instrument Manager to re-order the list of instruments. The Instrument Manager can be found in the Framework's **Options** Menu.

Chapter 4: Panel Indicators, Controls, and Connectors

The IPH has very few controls and indicators because it is fully computer-controlled. It has a lot of connectors because many connectors are duplicated so the system can connect eight instruments.

Front Panel

The IPH front panel has no connectors, no controls, and only two indicators.

Power On LED

The **Power On** LED is located on the lower right of the IPH front panel. It glows a steady blue when the Interface Power Hub is connected to a source of AC power and is turned on. It does **not** indicate the power status of the Interface family instruments installed in the IPH.

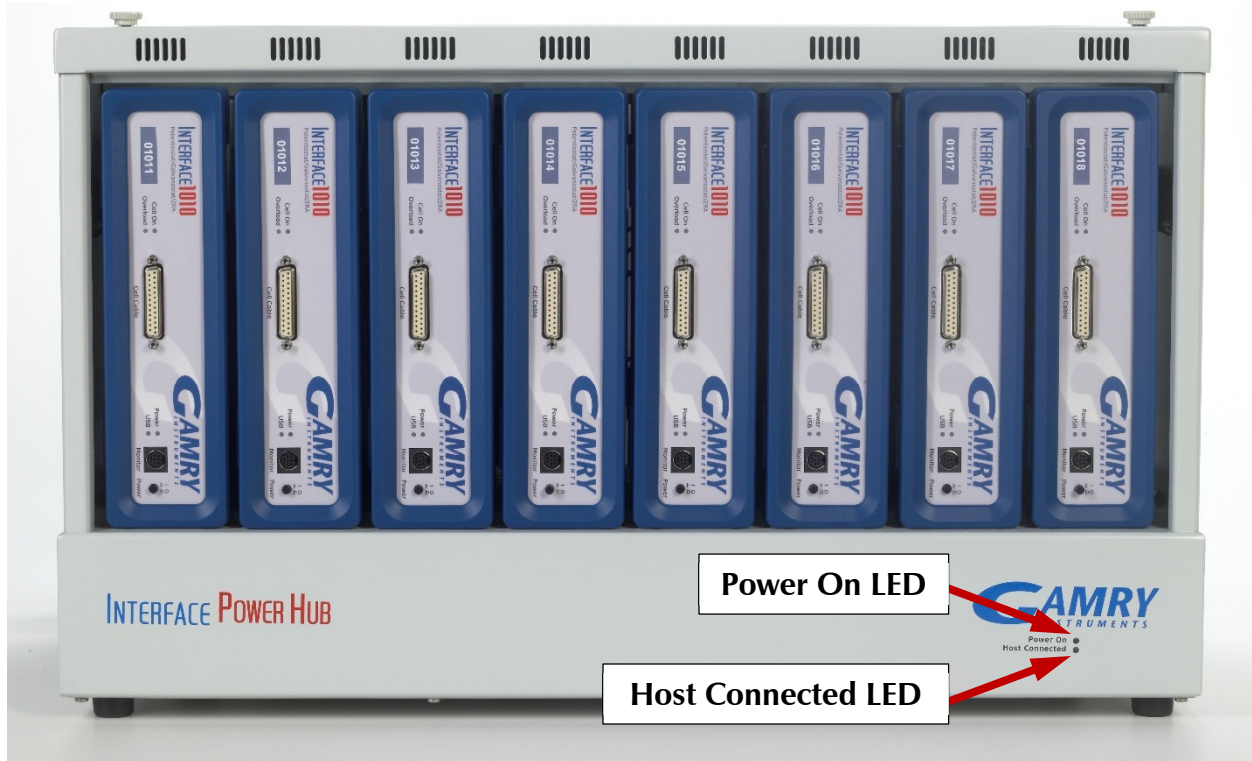

Host Connected LED

The **Host Connected** LED is also located on the lower right side of the IPH. It is yellow when there is an active host USB connection. This LED illuminates even when the IPH is not powered, for its power is derived from the host USB connection.

The **Host Connected** LED does not indicate USB data traffic. It simply indicates that a powered host connection exists.

Rear Panel

The rear panel contains one switch and many connectors.

Power Switch

The IPH power switch is built into an AC power module on the rear panel of the IPH. It is just above the AC line cord.

The AC power module also holds AC line fuses. See Chapter 1 for a discussion of these fuses and the proper fuse to use at different AC line (mains) voltages.

When the power switch is ON and a suitable AC line voltage is applied, AC-DC power supplies in the IPH produce +48 V DC and +5 V DC. The +5 V is then used to make a 3.3 V supply that powers the USB hub circuitry. These supplies supply power to four functional blocks in the IPH.

- The +48 V is generated to the eight **Power Out** ports on the IPH rear panel. These **Power Out** ports then provide DC power to the Interface potentiostats in the system.
- The +48 V also powers two fans that circulate air through the IPH, keeping the input air to the Interface instruments cool.
- The +5 V supply powers a 3.3 V DC power supply that in turn powers several USB hub ICs that form a 10-port USB hub.
- The +5 V supply also supplies +5 volts USB power for each of the 10 USB outputs. The USB power is overcurrent-protected for a total current of 500 mA. The protection is a resettable fuse rated for 500 mA. An Interface family potentiostat only requires about 5 mA of USB power-supply current.

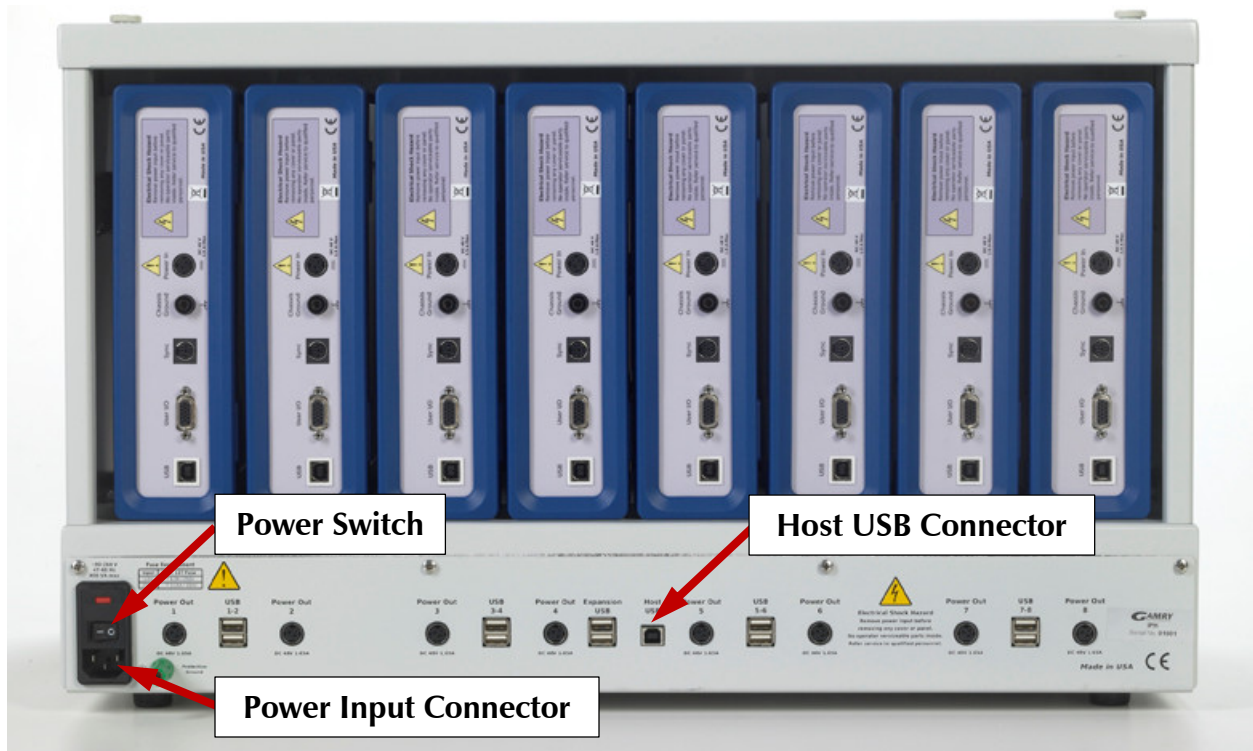

Power Input Connector

The AC Power Input is used to connect the IPH to an AC line voltage (mains). This connector is an IEC 60320 Type C14 male connector, often recognized as the AC line connector for desktop computers.

Connection requires a line cord with IEC 60320 IEC 320 C13 female connector. See additional information concerning AC line cords, input voltage ranges, and AC power fuses in Chapter 1 of this manual.

Host USB Connector

The **Host USB** connector is the only Type B USB port on the IPH. Type A USB connectors are rectangular while Type B connectors are almost square. The **Host USB** connector is used to connect a host computer to the IPH.

The host USB cable is a 1.8 m, filtered High-Speed USB A/B cable. It is connected between a USB port on your computer and the **Host USB** connector. A suitable cable was shipped with your Interface Power Hub. The replacement cable is Gamry Instruments part number 985-00131.

Instrument USB Ports

The IPH has eight numbered **USB** ports that are used for connection to Interface Family instruments. The numbers on the ports are unimportant except when reporting failures. The eight ports are implemented using four dual USB connectors. The two USB ports in the dual connector are stacked one atop the other.

The Instrument Ports are USB 2.0 High-Speed (480 Mbits/sec) Type A ports. Type A USB connectors are rectangular while Type B connectors are almost square.

Each instrument in the IPH is connected to a **USB** port using a short (23 cm) USB cable. The nearly square end of the cable (USB Type B connector) connects to the Instrument's USB port. The more rectangular end of the cable (USB Type A connector) connects to one of the numbered USB ports on the IPH.

USB connections can be "hot plugged." This means they can be connected to a powered Interface family instrument and a powered Host computer.

Replacement IPH USB cables are Gamry Instruments part number 985-00129. An IPH USB cable and an IPH power cable can be ordered together as Gamry Instruments part number 990-00301.

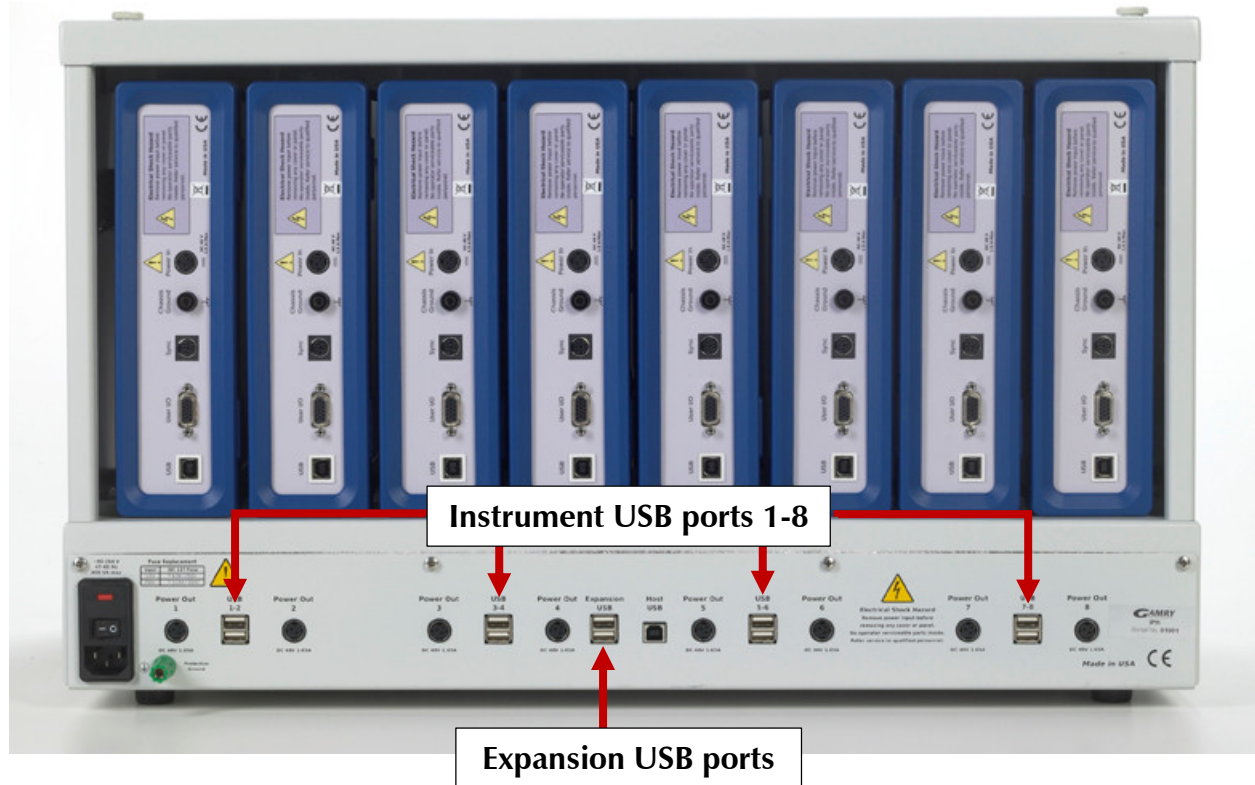

Expansion USB Ports

The IPH has two **Expansion USB** ports that are **not** used to connect to Interface family instruments. These ports are USB 2.0 High-Speed (480 Mbits/sec) ports, and use Type A USB connectors, which are rectangular.

They can be used to connect other IPHs, used to connect a software key, or used to connect a third-party USB device, such as a USB-to-RS232 Serial Converter.



Caution: Gamry Instruments, Inc. is not responsible for system failures or system slowdowns caused by third-party devices plugged into the IPH's expansion ports. A very high-bandwidth USB device connected to one of the expansion ports is likely to create system problems.

The **Expansion USB** ports do not support battery-charging via USB power. We do not recommend connection of cell phones, MP3 players, or tablet computers to these ports.



Caution: The total current drawn from all ten USB ports must be less than 500 mA. Interface family instruments typically requires less than 10 mA, so the total current drawn by the **Expansion USB** ports must be less than 420 mA. Over-current will trip a resettable fuse, which causes loss of data if the system is acquiring data.

Gamry also does not recommend connection of USB low-speed (1.5 Mbit/sec) or full-speed (12 Mbit/sec) devices to the IPH **Expansion USB** ports. USB "human interaction devices" such as a mouse or keyboard are likely to be low- or full-speed devices. Connection of this type of device can significantly slow the overall USB data rate.

Instrument Power Connections

The IPH has eight **Power Out** ports that provide +48 V DC power suitable for powering an Interface family potentiostat. There are 640 W of 48-V power available, which divided by the eight instruments, thus allowing 80 W per instrument.

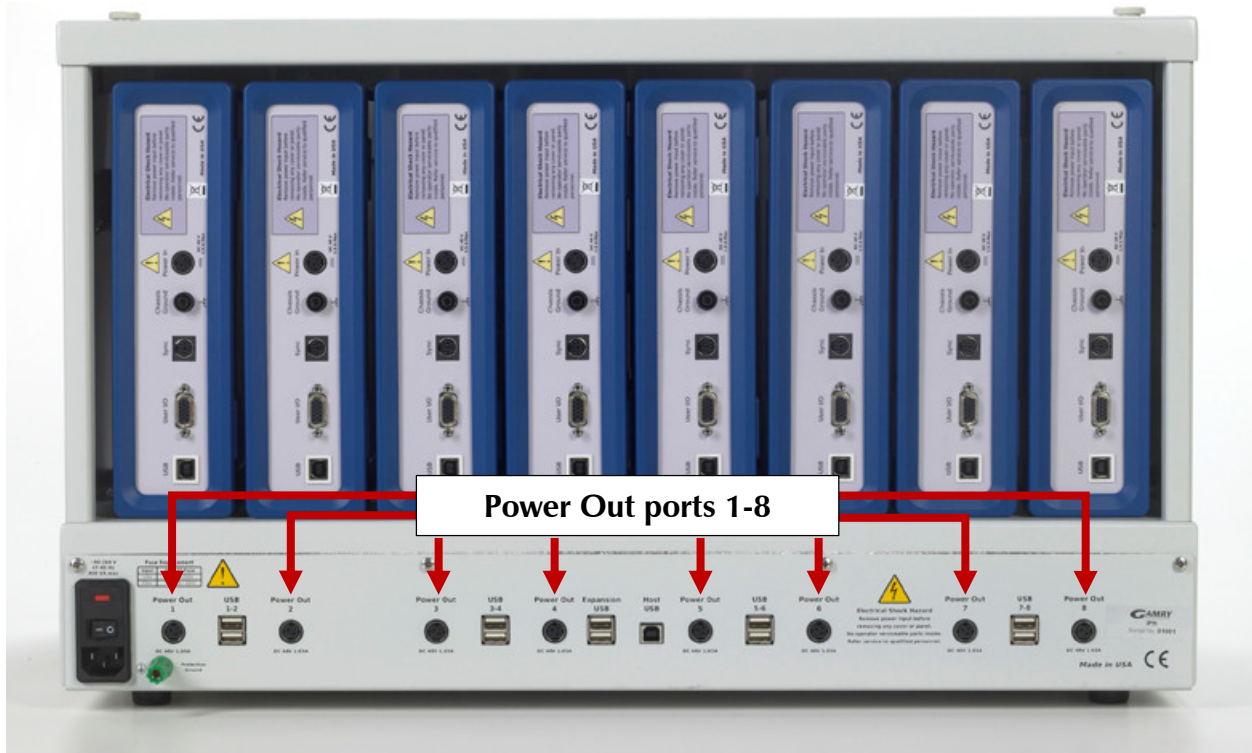

Each instrument in the IPH is powered using a short (35 cm) power cable. The cables have an identical 3-pin power DIN connector on each end. Each cable connects from a numbered IPH **Power Out** port to the **Power In** port on the instrument. The two ends of the cable are interchangeable.

Each instrument normally connects to the **Power Out** port immediately below it. The numbers on the ports are unimportant except when reporting failures. The cables are short enough that it is difficult to improperly connect them.

The power cables can be connected with the IPH power switch and the potentiostat power switches in the ON or OFF position. If both are ON, the instrument will power up when the connection is made. The cell switch on a newly power instrument is always open.

Replacement IPH power cables have the Gamry Instruments Part Number 985-00130. An IPH USB cable and an IPH power cable can be ordered together as Gamry Instruments Part Number 990-00301.

Appendix A: Interface Power Hub Specifications

All specifications are at an ambient temperature of 22°C with the Interface Power Hub powered from 115 VAC at 60 Hz, or 240 VAC at 50 Hz (unless otherwise noted).

All specifications are subject to change without notice.

USB Input

Speed	USB High Speed
Specification Compliance	USB 2.0
Maximum Input Current	100 mA

Instrument USB Ports

Speed	USB High Speed
Specification Compliance	USB 2.0
Typical Power Supply Current	<10 mA
Maximum Power Supply Current	50 mA

Expansion USB Ports

Speed	USB High Speed
Specification Compliance	USB 2.0
Maximum Power Supply Current (both ports) (assuming 10 mA/instrument)	420 mA

Environmental

Operating Temperature Range		0 to +45	°C
Relative Humidity	Max	90 (non-condensing)	%
Storage and Shipping Temperature		-40 to +75	°C
Maximum Shipping Acceleration		30	G

General

AC Line Input Voltage	90–264	V
Power	700	W
Dimensions	30 × 40 × 65 cm	cm
Weight	8	kg

Appendix B: Certifications



Declaration of Conformity: No. DOC-2012-CE-IPH

According to ISO/IEC Guide 22 and CEN/CENELEC EN 45014

Manufacturer's Name and Location:

Gamry Instruments
 734 Louis Drive
 Warminster, PA 18974
 USA

This declaration is for the Gamry Instruments product model: Interface Power Hub
 The declaration is based upon compliance with the following directives:

- EMC Directive 2004/108/EC
- Low Voltage Safety Directive 2006/95/EC

The declaration is based upon product compliance with the following standards as defined in report number R0609-000 from Ergonomics, Inc. for safety analysis and report number R-1866P from Retlif Testing Laboratories, Inc. for EMC test and analysis.

EMC Standards	Title	Class/ Criteria
EN 61326-1:2006 Table 1	EMC – Electrostatic discharge, Immunity	B
EN 61326-1:2006 Clause 7.2	EMC – Emissions	A

Low Voltage Directive Safety Standards	Title
EN 61010-1:2010	Safety requirements for electrical equipment for measurement, control and laboratory use, Part 1: General requirements

Signature

November 20, 2012

Date

Dr. Gregory A. Martinchek, PhD
 Title: President

Formal signed declaration is on file at Gamry, Inc.

Certificate of Conformance

	324 Second Street Pike Southampton, PA 18966, USA Phone: (1) 215 357 5124 Fax: (1) 215 364 7582 email: info@Ergonomicsusa.com Website: www.Ergonomicsusa.com
---	---

Certificate of Conformance

European Community Low Voltage Directive 2006/95/EC

Certificate Issued to:

Gamry Instruments
734 Louis Drive
Warminster, PA 18974
USA

Manufacturing Location:

Gamry Instruments
734 Louis Drive
Warminster, PA 18974
USA

This certificate is only issued for the products described and listed in Ergonomics, Inc. Report Number R0609-000.

Product tested:

The product tested was model part number 990-00295, serial number pre production. This included PCB #990-00294. Consult Ergonomics, inc. report number R0609-000 for full range of products included in this certificate.

Issued by:

Ergonomics, Inc.
324 Second Street Pike
Southampton, PA 18966
USA

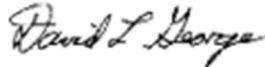

David L. George, PE, Director

Applicable Standard:

EN 61010-1:2010 - Safety requirements for electrical equipment for measurement, control and laboratory use - Part 1: General Requirements.

Date of Issue: August 16, 2012



Retlif Testing Laboratories

3131 Detwiler Road, Harleysville, PA 19438
215-256-4133 - Fax: 215-256-4130

CORPORATE OFFICE
785 Marconi Avenue
Rosetonoma, NY 11778
631-737-1500 Fax 631-737-1497
(A NY Corporation)
BRANCH LABORATORIES
101 New Boston Road
Goffstown, NH 03045
603-497-4600 Fax 603-497-5281
WASHINGTON
REGULATORY OFFICE
703-533-1614 Fax 703-533-1612



November 20, 2012

Ms. Michelle Taylor
Gamry Instruments
734 Louis Drive
Warminster, PA 18974

Dear Ms. Taylor,

This letter is to certify that the Interface Power Hub (IPH), System Level Part Number: 990-00297, was tested to the requirements of EN 61326-1: 2006 for the following methods:

Test Method	Testing Dates	Test Results
CISPR 11, Conducted Emissions, Class A	October 31, 2012	Complied*
CISPR 11, Radiated Emissions, Class A	October 31, 2012	Complied*
IEC 61000-3-2, Harmonics	October 31, 2012	Complied
IEC 61000-3-3, Voltage Fluctuation and Flicker	October 31, 2012	Complied
IEC 61000-4-2, Electrostatic Discharge	August 7, 2012	Complied
IEC 61000-4-3, Radiated Immunity	August 3, 2012	Complied
IEC 61000-4-4, Electrical Fast Transient/Burst, Power Ports	November 2, 2012	Complied*
IEC 61000-4-5, Surge Immunity, Power Ports	November 1, 2012	Complied*
IEC 61000-4-6, Conducted Immunity, Power Ports	November 1, 2012	Complied
IEC 61000-4-11, Voltage Dips, Interrupts and Variations	November 15, 2012	Complied

*Modifications were made to the EUT during the course of this testing program in order to demonstrate compliance.

This testing was performed in accordance with your Purchase Order Number: 2012-0711. Your formal test report will be submitted to you shortly under Retlif Testing Laboratories Report Number R-1866P.

I trust this fulfills your present needs. If you should have any questions, please feel free to contact me.

Sincerely,

Retlif Testing Laboratories

Richard J. Reitz
Corporate Laboratory Manager



Declaration of Conformity: No. DOC-2022-UKCA-IPH

According to ISO/IEC Guide 22 and CEN/CENELEC EN 45014

Manufacturer's Name and Location:

Gamry Instruments
 734 Louis Drive
 Warminster, PA 18974
 USA

This declaration is for the Gamry Instruments product model: Interface Power Hub
 The declaration is based upon compliance with the following directives:

- EMC Directive 2004/108/EC
- Low Voltage Safety Directive 2006/95/EC

The declaration is based upon product compliance with the following standards as defined in report number R0609-000 from Ergonomics, Inc. for safety analysis and report number R-1866P from Retlif Testing Laboratories, Inc. for EMC test and analysis.

EMC Standards	Title	Class/ Criteria
EN 61326-1:2006 Table 1	EMC – Electrostatic discharge, Immunity	B
EN 61326-1:2006 Clause 7.2	EMC – Emissions	A

Low Voltage Directive Safety Standards	Title
EN 61010-1:2010	Safety requirements for electrical equipment for measurement, control and laboratory use, Part 1: General requirements



Signature

August 31, 2022
 Date

Dr. Gregory A. Martinchek, PhD
 Title: President

Formal signed declaration is on file at Gamry, Inc.

Appendix C: Comprehensive Index

- AC line cord, 7
- AC line voltage, 8
- AC power, 36
- adding an instrument, 32
- adding instruments, 26
- air-cooling, 10
- authorization codes, 29
- CE Compliance, 13
- cleaning, 12
- computer, 4, 13, 20
- computer requirements, 20
- contract engineering, 3
- conventions
 - notational, 17
- Cover Plate, 28, 30
- cover plates, 30
- Declaration of Conformity, 43, 46
- earth ground, 10
- electrical transients, 12
- enclosed space, 11
- environmental limits, 11
- environmental stress, 11
- Expansion USB, 23
- Expansion USB** ports, 16, 23, 24, 29, 37, 38
- Faraday cage, 12
- Framework, 15, 17, 19, 23, 25, 26, 30, 31, 32, 33
- fuses, 8, 9, 10, 21, 36
- grounding, 7, 10
- Hold-down Bar, 26
- Hold-down Knobs, 25, 32, 33
- Hold-Down Knobs, 26
- Hold-down mechanism, 25
- Host Connected** LED, 30, 35
- Host USB** connector, 36
- inspection, 7
- installation, 19
- Instrument Manager, 26
- instrument order, 26
- instrument USB ports, 37
- IPH cable kit, 29
- labeling, 26
- line cord, 7, 8, 9, 21, 35, 36
- manual overview, 15
- Master/Serf, 17
- multiple tests, 31
- operation, 11
- power cable - DC, 29
- Power Connection, 21
- power cord, 9, 15, 22
- Power Cord - AC, 21
- power down, 30
- Power Input, 36
- power line transient, 13
- Power On** LED, 22, 30, 35
- Power Out port, 28
- Power Out** ports, 28, 36, 38
- Power Switch, 22, 35
- power up test, 22
- protective grounding, 7
- Quick Start Guide, 20
- radio frequency, 12
- removing an instrument, 32
- RoHS Compliance, 13
- safety, 7
- Sequence Wizard, 31
- service, 12
- service contract, 3
- software installation, 20
- specifications, 41
- static electricity, 13
- storage, 11
- support, 3
- Sync port, 17
- system test, 30
- telephone assistance, 3
- temperature, 10
- transportation, 15
- USB cable, 22, 29, 37
- USB dongle, 29
- USB hub, 16, 23
- warranty, 3
- Windows, 4