

GAMRY INSTRUMENTS

eQCM 10M™

Impedance Scanning

Electrochemical Quartz Crystal Microbalance

Operator's Manual



Copyright © 2012–2016 Gamry Instruments, Inc.
Revision 7.1
November 14, 2016

988-00020

If You Have Problems

Please visit our service and support page at www.gamry.com/service-support/. This page contains information on installation, software updates, and training. It also contains links to the latest available documentation. If you cannot find the information you need from our website, contact us via email using the link provided on our website. Alternatively, you can contact us one of the following ways:

Internet www.gamry.com/service-support/
Telephone (215) 682-9330, 9:00 AM–5:00 PM, US Eastern Standard Time
 (877) 367-4267 Toll Free US & Canada Only

Please have your instrument model and serial numbers available, as well as any applicable software and firmware revisions.

If you have problems in installation or use of a system containing an eQCM10M, try to call from a phone next to your computer, where you can type and read the screen while talking to us.

We will be happy to provide a reasonable level of free support for registered users of the eQCM10M. Reasonable support includes telephone assistance covering the normal installation, use and simple customization of a computerized system containing an eQCM10M connected to a Windows[®]-compatible computer.

A service contract that extends both the hardware warranty and software update period is available at an additional charge. Software updates *do not* include software enhancements offered to our customers at additional cost.

Enhancements to the eQCM10M and Gamry's standard applications software that require significant engineering time on our part can be performed on a contract basis. Contact us with your requirements.

Limited Warranty

Gamry Instruments, Inc. warrants to the original user of this product that it shall be free of defects resulting from faulty manufacture of the product or its components for a period of two years from the original shipment date of your purchase.

Gamry Instruments, Inc. makes no warranties regarding either the satisfactory performance of the eQCM 10M including the software provided with this product or the fitness of the product for any particular purpose. The remedy for breach of this Limited Warranty shall be limited solely to repair or replacement, as determined by Gamry Instruments, Inc., and shall not include other damages.

Gamry Instruments, Inc. reserves the right to make revisions to the system at any time without incurring any obligation to install same on systems previously purchased. All system specifications are subject to change without notice.

There are no warranties which extend beyond the description herein. This warranty is in lieu of, and excludes any and all other warranties or representations, expressed, implied or statutory, including merchantability and fitness, as well as any and all other obligations or liabilities of Gamry Instruments, Inc; including but not limited to, special or consequential damages.

This Limited Warranty gives you specific legal rights and you may have others, which vary from state to state. Some states do not allow for the exclusion of incidental or consequential damages.

No person, firm or corporation is authorized to assume for Gamry Instruments, Inc., any additional obligation or liability not expressly provided herein except in writing duly executed by an officer of Gamry Instruments, Inc.

Disclaimers

Gamry Instruments, Inc. cannot guarantee that the eQCM 10M will work with all computer systems, operating systems, and third-party software applications hardware/software.

The information in this manual has been carefully checked and is believed to be accurate as of the time of printing. However, Gamry Instruments, Inc. assumes no responsibility for errors that might appear.

Copyrights and Trademarks

eQCM 10M™ Impedance Scanning Electrochemical Quartz Crystal Microbalance Operator's Manual: copyright © 2012–2016 Gamry Instruments, Inc., all rights reserved.

Gamry Framework copyright © 1989–2016 Gamry Instruments, Inc., all rights reserved.

Reference 600™, Reference 3000™, eQCM 10M™, Gamry Framework™, and Gamry™ are trademarks of Gamry Instruments, Inc.

Windows® is a registered trademark of Microsoft Corporation. Teflon is a registered trademark of Chemours.

No part of this document may be copied or reproduced in any form without the prior written consent of Gamry Instruments, Inc.

Table of Contents

Chapter 1: Safety Considerations	7
Inspection	7
Product Safety	7
AC Mains Connection to the Power Brick	7
Grounding in the eQCM 10M	8
Temperature and Ventilation	8
Defects and Abnormal Stresses	9
Environmental Limits	9
Cleaning	9
Service	9
Emission Warning	10
Electrical Transient Sensitivity	10
CE Compliance	10
RoHS Compliance	10
Chapter 2: Introduction	12
About this Manual	12
About the eQCM 10M	12
Notational Conventions	12
Chapter 3: Instrument Circuitry	14
eQCM 10M Schematic/Block Diagram	14
Chapter 4: Installation	17
Initial Visual Inspection	17
Physical Location	18
Computer Requirements	18
Plug & Play System Configuration	18
Power Cord and Power Connection	18
Power-Up Test	20
USB Connection	21
First-Time Device Installation in Windows	21
Chapter 5: Cell Connections	23
Normal Cell Connections	23
Quartz Crystal Installation	23
Chapter 6: Panel Indicators and Connectors	35
Front Panel	35
Quartz Connector	35
Power LED	35
The Data LED	35
Rear Panel	36
Power Jack	36
Power Switch	36
GND	36
USB Port	37
Chapter 7: eQCM 10M Specifications	38
Chapter 8: CE Certificate	39

Declaration of Conformity	39
Chapter 9: Comprehensive Index	41

Chapter 1: Safety Considerations

Your eQCM 10M has been supplied in a safe condition. This chapter of the eQCM 10M Operator's Manual contains information and warnings that you must follow to insure continued safe operation of the eQCM 10M.

Inspection

When you receive your eQCM 10M Impedance Scanning Electrochemical Quartz Crystal Microbalance, inspect it for evidence of shipping damage. If any damage is noted, please notify Gamry Instruments Inc. and the shipping carrier immediately. Save the shipping container for possible inspection by the carrier.



Warning: An eQCM 10M damaged in shipment can be a safety hazard. Do not operate damaged apparatus until a qualified service technician has verified its safety. Tag a damaged eQCM 10M to indicate that it could be a safety hazard.

Product Safety

The eQCM 10M is designed, tested, and certified to meet the requirements of EN 61010, *Safety requirements for **electrical equipment** for measurement, control, and laboratory use*. As defined in this standard, it is a Category I apparatus, designed for connection to circuits other than the power mains.

The instrument contains a limited amount of internal circuitry that is at "hazardous live" voltages as defined in EN 61010 (the standard mentioned above). "Reinforced insulation" (again defined in EN 61010) is used to reduce the risk of electrical shock due to this "hazardous live" voltage.

As a generalization, input and output voltages in the eQCM 10M are limited to 12 V. This voltage level is considered safe.

The AC Adapter supplied with the instrument is certified under EN 60950. The AC Adapter converts the AC mains voltage to 12 V DC, which is used to power the instrument.

Always use the AC adapter (power brick) supplied with your eQCM 10M to supply DC power to the instrument.



Caution: Use only Gamry-approved DC power sources with your eQCM 10M. Other power sources may alter the performance and/or safety characteristics of the eQCM 10M.

AC Mains Connection to the Power Brick

The eQCM 10M does not connect directly to an AC Mains supply. Instead, the mains are connected to a desktop AC adapter (power brick), which outputs 12 V DC, which in turn powers the instrument.



The instrument's AC Adapter is rated for operation from 100 to 240 V AC, 47 to 63 Hz. It should therefore be useful throughout the world.

Safety Considerations--Grounding in the eQCM 10M

The instrument is normally provided with an AC line cord suitable for your location. This AC line cord connects the AC mains to the AC power adapter. If your instrument has been provided without an AC line cord, or a cord that is not compatible with your local AC mains socket, obtain a line cord certified for use in your country. Contact your local Gamry Representative or Email to techsupport@gamry.com if you are uncertain what AC line cord to use.

Grounding in the eQCM 10M

A Chassis Ground binding post on the rear panel of the eQCM 10M is provided for a connection to earth ground. Simply run a wire from this binding post to a suitable source of earth ground. A black 1.2-m wire is provided to ease this connection.



Sources of earth ground include

- Most metal water pipes,
- The chassis of **most** electronic apparatus (which are generally earth-grounded), and
- The protective ground terminal of an AC mains power plug.

We recommend that you discuss grounding with an electrical or electronics professional prior to making this earth-ground connection.

Note that this connection of the instrument to an earth ground is not a "Protective Earth Ground" as defined in EN 61010.

This binding post is not intended for any use other than connecting the eQCM 10M to an earth ground to improve shielding against noise. Connecting this binding post to a hazardous voltage can create a significant safety hazard.



Warning: Do not connect the chassis-ground binding post to any voltage other than earth ground. An improper connection can create a safety hazard, which could result in personal injury or death.

Temperature and Ventilation

Your eQCM 10M Impedance Scanning Electrochemical Quartz Crystal Microbalance was designed for indoor use at ambient temperatures between 0°C and 45°C.



Caution: Do not block the airflow around the instrument chassis. While the circuitry should suffer no damage due to excessive heat, the enclosure may become uncomfortably hot to the touch with insufficient air flow around the chassis.

Be careful when operating the instrument in an enclosed space (such as an enclosed relay rack or NEMA enclosure). The temperature within the enclosure must not exceed 45°C. You may need to provide ventilation holes or even forced air-cooling for the enclosed space if excessive temperature rise occurs.

Defects and Abnormal Stresses

Treat your eQCM 10M as potentially hazardous if any of the following is true of the unit:

- It shows visible damage,
- It does not operate properly,
- It has been stored for a long period of time under unfavorable conditions,
- It has been dropped or subjected to severe transport stress,
- It has been subjected to environmental stress (corrosive atmosphere, fire, etc.).

Do not use your eQCM 10M or any other apparatus if you think it could be hazardous. Have it checked by qualified service personnel.

Environmental Limits

Note that there are environmental limits on the storage, shipping and operation of this equipment. The eQCM 10M has *not* been designed for outdoor use.

<i>Storage</i>	Ambient temperature	-40 °C to 75 °C
	Relative humidity	Maximum 90% non-condensing
<i>Shipping</i>	Same as storage plus	
	Acceleration	Maximum 30 g
<i>Operation</i>	Ambient temperature	0 °C to 45 °C
	Relative humidity	Maximum 90% non-condensing



Warning: This instrument is not designed for operation in conditions where liquid water may enter the chassis, or water vapor may condense within the chassis. Operation of an Interface 5000 that has water within the chassis can create a safety hazard, which could result in personal injury or death

Cleaning

5. Disconnect the eQCM 10M from all power sources prior to cleaning.
6. Use a cloth *lightly* dampened with either clean water, or water containing a mild detergent, to clean the outside of the enclosure. Alternatively, you can use isopropyl alcohol. Do not use a wet rag or allow fluid to enter the enclosure. Do not immerse the instrument in any type of cleaning fluid (including water). Do not use any abrasive cleaners.

Service

Your eQCM 10M Impedance Scanning Electrochemical Quartz Crystal Microbalance has no user-serviceable parts inside. Refer all service to a qualified service technician.



Warning: Never operate the eQCM 10M with any cover or panel on the chassis open. Dangerous voltages may be present at several points within the eQCM 10M chassis, including PC board traces. Always remove the power connection before opening the eQCM 10M case.

Emission Warning

Your eQCM 10M Impedance Scanning Electrochemical Quartz Crystal Microbalance generates, uses, and can radiate radio-frequency energy. The radiated levels are low enough that the instrument should not create an interference problem in most industrial laboratory environments.

The eQCM 10M has been tested for both radiated and conducted RF interference and has been found to be in compliance with EN 50081-1, 55011, and 55022 and 61000-4-3.

Electrical Transient Sensitivity

Your eQCM 10M Impedance Scanning Electrochemical Quartz Crystal Microbalance was designed to offer reasonable immunity from electrical transients, including transients on the incoming AC Mains supply and Electrostatic Discharge. It has been tested for compliance with EN 580082-2, 61010-1, and EN 61010-2-081. The eQCM 10M is not rated for continuous use when subject to ESD events. It should suffer no permanent damage when subject to the standard ESD events defined in EN61000-4-2, but may cease normal operation until it is switched off and restarted.

In severe cases, the instrument could malfunction as a result of electrical transients such as a static discharge. If you are having problems in this regard, the following steps may help:

If the problem is static electricity (sparks are apparent when you touch the instrument or its cables):

- Placing the instrument on a static control work surface may help. Static control work surfaces are now generally available from computer supply houses and electronics tool suppliers. An antistatic floor mat may also help, particularly if a carpet is involved in generating the static electricity.
- Air ionizers or even simple air humidifiers can reduce the voltage available in static discharges.

If the problem is AC power line transients (often from large electrical motors near the instrument):

- Try plugging your eQCM 10M into a different AC power branch circuit.
- Plug your eQCM 10M into a power-line surge-suppressor. Inexpensive surge-suppressors are now generally available because of their use with computer equipment.

Contact Gamry Instruments, Inc. if these measures do not solve the problem.

CE Compliance

The European Community has instituted standards limiting radio-frequency interference emitted by electronic devices, setting limits for susceptibility of apparatus to RF energy and transient events, and mandating safety requirements. The eQCM 10M Impedance Scanning Electrochemical Quartz Crystal Microbalance has been tested to comply with these standards.

The relevant CE regulations include EN 61010 and EN 61326.

RoHS Compliance

The eQCM 10M Impedance Scanning Electrochemical Quartz Crystal Microbalance has been built using lead-free components and lead-free solder. It is in compliance with the European RoHS initiative.

Chapter 2: Introduction

About this Manual

This manual covers the installation, safety, and use of the eQCM 10M Impedance Scanning Electrochemical Quartz Crystal Microbalance.

This manual describes use of an eQCM 10M with Revision 7.0 (and later revisions) of the Gamry Resonator software.

Chapter 1 was an in-depth discussion of safety issues. This chapter describes this manual and gives a brief overview of the eQCM 10M features. Chapter 3 is a description of the electronics circuitry in the eQCM 10M. Chapter 4 contains installation instructions. Chapter 5 describes inserting a crystal into a holder and connecting the holder to the eQCM 10M, and Chapter 6 describes the eQCM 10M's front and rear panels. Specifications are in Chapter 7.

This manual does not discuss software installation or software operation in any detail.

Software support for the eQCM 10M is described in the Gamry's On-line Help system and associated documentation.

About the eQCM 10M

The eQCM 10M is a research-grade electrochemical instrument packaged in a small, easy-to-handle case. It offers measurement capabilities similar to instruments that are more than ten times its size and weight, and more than two times its price. The instrument can operate as a stand-alone quartz-crystal microbalance or with a potentiostat.

eQCM 10M features include:

- 1–10 MHz operating range with no need to send the unit back to the factory in order to recalibrate for different frequency crystals
- DC-decoupled output for interface with a potentiostat
- 0.02 Hz resolution
- Reporting of both the series and parallel resonance frequencies
- An insulated USB connection avoiding ground loops

The eQCM 10M, like all Gamry instruments, requires a host computer for its use. Unlike some other quartz crystal microbalances, the instrument connects to the computer through a USB cable. The USB connection has become truly universal, with USB ports found on all modern computers.

Notational Conventions

In order to make this manual more readable we have adopted some notational conventions. These are used throughout this manual and all other Gamry Instruments manuals:

- Numbered lists. A numbered list is reserved for step-by-step procedures, with the steps always performed sequentially.
- Bulleted list. The items in a bulleted list, such as this one, are grouped together because they represent similar items. The order of items in the list is not critical.

Introduction--Notational Conventions

- File names and folders. Inside paragraphs, references to computer files and Windows® folders are capitalized and placed within quotes, for example: "C:\MYGAMRYDATA\EQCM.DTA" and "GAMRY5.INI"

Chapter 3: Instrument Circuitry

eQCM 10M Schematic/Block Diagram

If you are not familiar with electronic schematics or quartz crystal microbalances, you probably want to skip this chapter. This information is for expert use only and is not required for routine use of the instrument.

The following figure is part schematic diagram and part block diagram. They are intended to show the basic principles of the instrument without the confusion of the full circuitry details.

The schematic/block diagram figure shows the quartz-crystal microbalance board.

Figure 2-1
eQCM 10M Impedance Scanning Quartz Crystal Microbalance board,
simplified schematic/block diagram

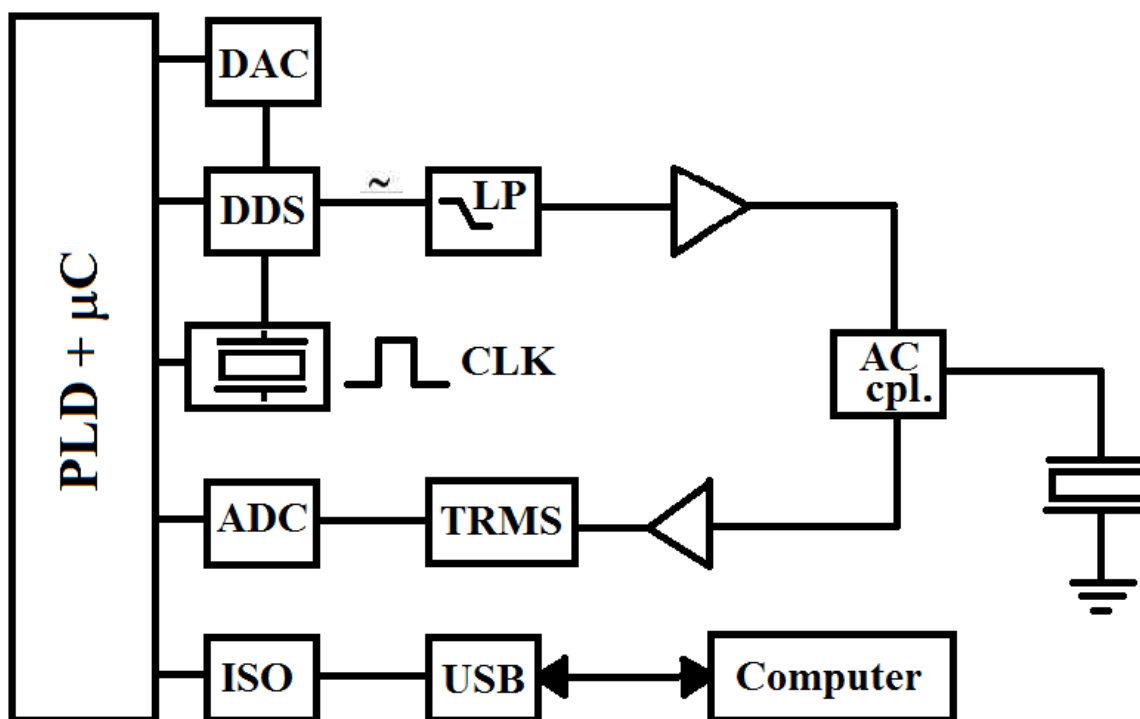

Notes for Figure 2-1

- The programmable logic device (PLD) acts as the core of the QCM. Sine waves of varying frequencies and amplitude are generated by the DDS, in 4096 steps from 0.05 to 8.33 V_{rms} . The PLD and DDS are driven by the same primary 80 MHz clock (CLK).
- Output from the DDS is filtered through a 4th-order low-pass filter (LP) with a cut-off range of 15 MHz. This signal is amplified by a high-speed current-feedback operational amplifier. The amplified signal is passed through the AC coupler (AC cpl.) and injected into the quartz crystal.
- The coupler allows integration to a potentiostat for electrochemical studies. The output signal from the crystal is coupled out by the same network. The signal is then passed through an RMS-to-DC (TRMS) converter and evaluated by a successive-approximation A/D-converter (ADC).
- The PLD then performs some low-level mathematical functions and delivers the data to a ground-isolated (ISO) USB interface (USB).

Instrument Circuitry--eQCM 10M Schematic/Block Diagram

Chapter 4: Installation

This chapter of the Gamry Instruments Inc. eQCM 10M Operator's Manual covers normal installation of the instrument.

Figure 2 - 1
View of an eQCM 10M



Initial Visual Inspection

After you remove your eQCM 10M from its shipping carton, check it for any signs of shipping damage. If you find any damage, please notify Gamry Instruments, Inc. and the shipping carrier immediately. Save the shipping container for possible inspection by the carrier.



Warning: The "reinforced insulation" that keeps the operator from accessing the "hazardous live" voltages in the instrument can be rendered ineffective if the eQCM 10M is damaged in shipment. Do not operate damaged apparatus until a qualified service technician has verified its safety. Tag a damaged eQCM 10M to indicate that it could be a safety hazard.



Caution: If the eQCM 10M is taken from a cold location (for example, outdoors in winter conditions) to a warm, humid location, water vapor could condense on the cold surfaces inside the instrument, possibly creating a hazardous condition. Before connecting power to a "cold" eQCM 10M, allow at least one hour for the instrument to warm up to room temperature.

Physical Location

Place your eQCM 10M on a flat workbench surface. Have access to the rear of the instrument because some cable connections are made from the rear. The eQCM 10M is generally operated in a horizontal position (see Figure 2-1). Operation in other positions is possible as long as you insure that air movement around the chassis is not restricted.



Caution: Do not block the airflow around the chassis. While the circuitry should suffer no damage due to excessive heat, the enclosure may become uncomfortably hot to the touch if no air flows around the chassis. Running the instrument without adequate cooling could shorten the time to failure of some of the circuitry.

If you place your eQCM 10M within an enclosed space, make sure that the internal temperature within that space does not exceed the 45°C ambient temperature-limit of the eQCM 10M. Be particularly careful if a computer or other heat-dissipating equipment is mounted within the same enclosure.

The eQCM 10M is not designed for outdoor use.

Computer Requirements

Before you connect an eQCM 10M to a computer you must make sure that your computer meets these simple requirements.

- A computer based on one of the x86 or x64 families of Intel microprocessors, or a 100%-compatible processor from another vendor,
- Microsoft® Windows® 7 or newer is required. Both 32-bit and 64-bit versions of these operating systems are supported. See the Gamry website "www.gamry.com" if you have a newer edition of Windows®.
- A USB port that supports Full Speed (12 Mb/second) or High Speed (480 Mb/second) USB transfers. It must be compatible with Revision 1.1 or Revision 2.0 of the USB specification.

Plug & Play System Configuration

The eQCM 10M is completely compatible with the Windows Plug & Play configuration system. Like most Plug & Play hardware, it is best if you install the software for the eQCM 10M **before** you install the hardware.

A Setup program normally starts up automatically when you place the Gamry Instrument's Software CD into the CD drive on your computer. Consult Gamry's software installation manual if you need assistance accessing the Setup program or choosing options in its menus.

Power Cord and Power Connection

The eQCM 10M does not plug directly in the AC mains supply. Instead, the mains are connected to an external power supply, which supplies a regulated 12-volt DC output. This regulated DC is then connected to the DC power input jack on the rear of the instrument.

The external power supply provided with the instrument is rated for operation from 100 to 240 V AC, at frequencies from 50 to 60 Hz. It should therefore be usable worldwide.

The eQCM 10M external supply is supplied with a line cord suitable for use in the United States. In other countries, you may have to replace the line cord with one suitable for your electrical outlet type. You must

Installation--Power Cord and Power Connection

always use a line cord with a CEE 22 Standard V female connector on the apparatus end of the cable. This is the same connector used on the US standard line cord supplied with your instrument. See Chapter 1 for specific safety information regarding line-cord selection.

The DC output cord from the external power supply plugs into the DC Power input jack on the rear panel of the eQCM 10M (see Figure 2-2).

Figure 2 - 2
Rear panel of the eQCM 10M



Caution: Only use the supplied, 12-volt DC power supply for the eQCM 10M. Connection of a 24-volt DC power supply, such as the one supplied with a Reference 600 or Reference 3000, will cause damage to the unit.

Power-Up Test

Before you make any other connections to your eQCM 10M, check that the instrument is at least nominally functional.

One quick test is to turn on the eQCM 10M and watch the blue **Power** LED indicator on the front panel.



After connecting DC power to the instrument, turn on the **Power** switch to **On**.

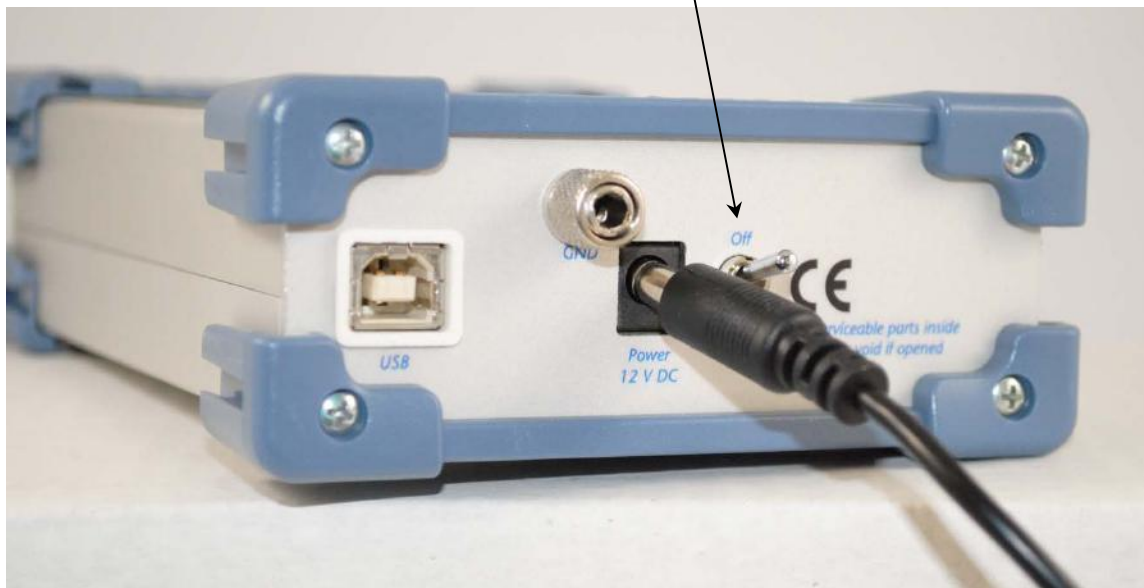

The **Power** LED should illuminate and remain on.

The status of the other LED indicator is not important at this time.



Caution: If the power LED goes on, then turns off and does not come on, the eQCM 10M is not working properly! Contact Gamry Instruments or your local Gamry Instruments representative as soon as possible if this power up test fails.

USB Connection

The eQCM 10M connects to the computer using a standard High Speed USB A/B cable. A suitable cable was shipped with your instrument. If this cable is lost, you can get a replacement at almost any computer retailer. The replacement cable should be rated for USB 2.0 high-speed USB operation.

An A/B USB cable has different connectors on each end. The end with a wider, rectangular-shaped connector plugs into a USB port on your computer (or a similar port on a USB hub). The end with a nearly square connector plugs into the **USB** port on the eQCM 10M (see Figure 2 - 3).

Figure 2 - 3
Rear panel of the eQCM 10M with USB cable



The USB connection can be “hot-plugged”. This means both the computer and the eQCM 10M can be switched on before the USB cable is plugged in. Unlike many other instrument-system connections, you need not power down the system before plugging in the USB.

You can also safely remove the USB cable without powering down the eQCM 10M and your computer. Be aware however, that this may have undesirable consequences if the system is currently taking data or performing an electrochemical experiment.

First-Time Device Installation in Windows

Installation in Windows 7 is automated after the proper drivers have been installed according to the Quick-start Guide. No user interaction is necessary.

Chapter 5: Cell Connections

Normal Cell Connections

Each eQCM is shipped with a standard, shielded BNC cable terminated with a ceramic adapter (part # 985-00124). Attach the male end of the cable to the front panel of the eQCM 10M (see Figure 5-1).

Figure 5 - 1
Connection of Cell Cable



Quartz Crystal Installation

1. Attach vial-side plate to main block with two long screws. Tighten to snug-fit.

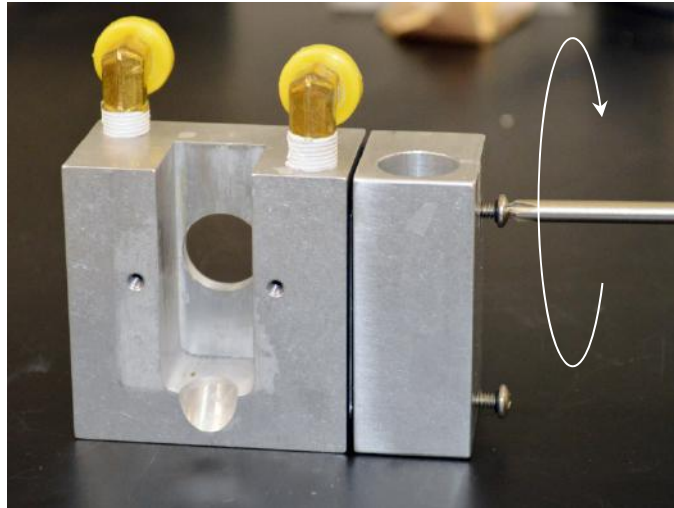

Cell Connections--Quartz Crystal Installation

2. Attach side plate to main block with two short screws. Tighten to snug-fit.

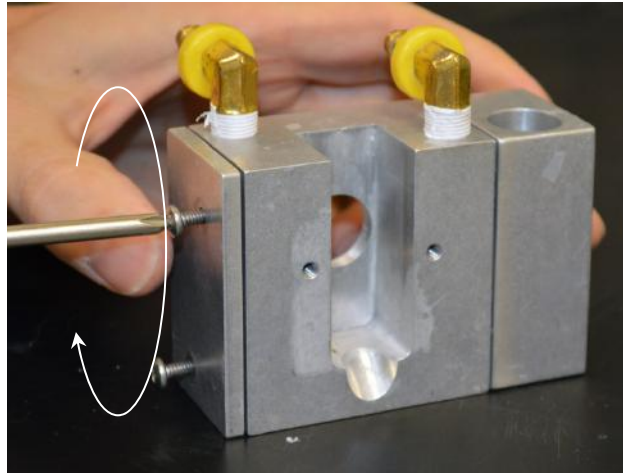

3. Press PEEK crystal holder into main block.

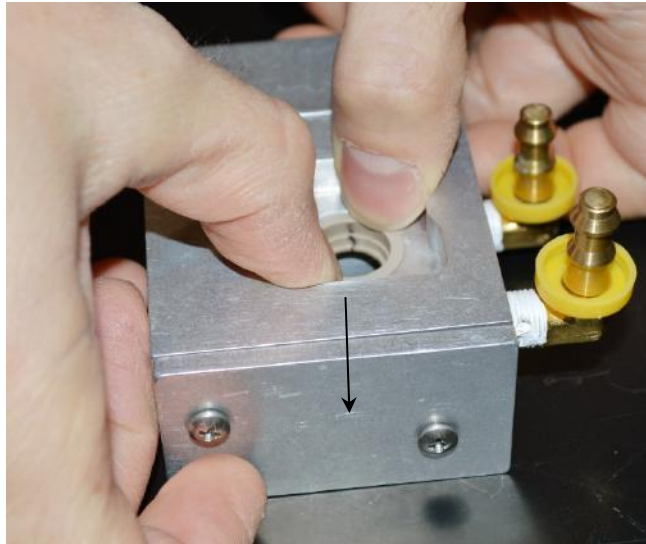

4. Carefully place O-ring into mounted crystal holder.

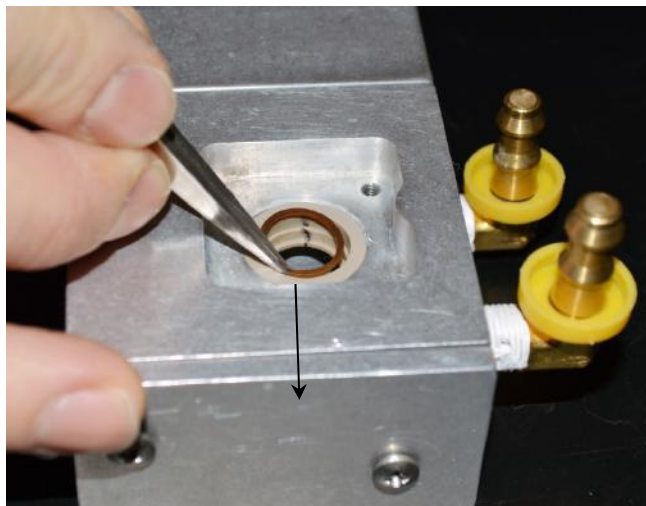

Cell Connections--Quartz Crystal Installation

- Using tweezers, carefully place quartz crystal into crystal holder.

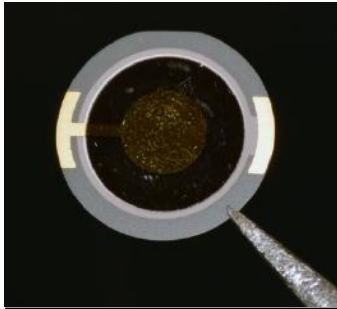

→ DON'T FORGET!

Note orientation of crystal: The flat edge MUST be at the top (12 o'clock position) and the two electrical contacts MUST be at the left and right (3 o'clock and 9 o'clock positions)

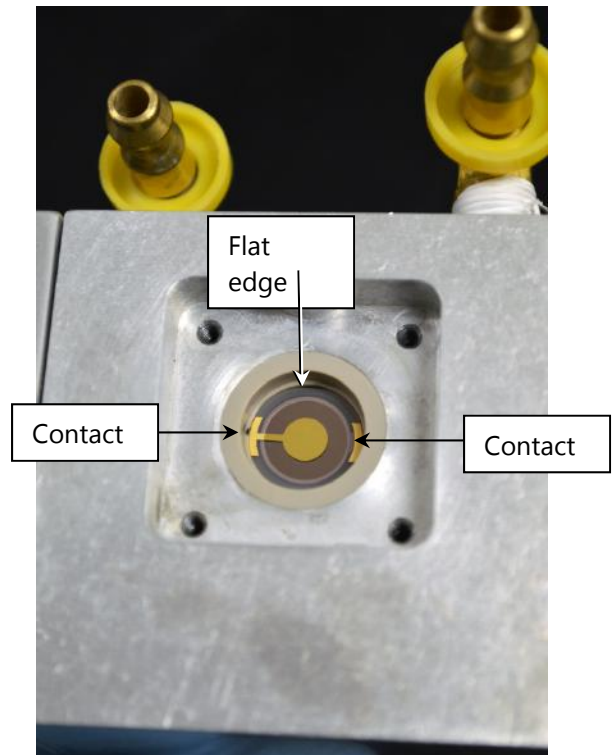

- Press-fit BNC mount into main block, until it is flush with the exterior surface.

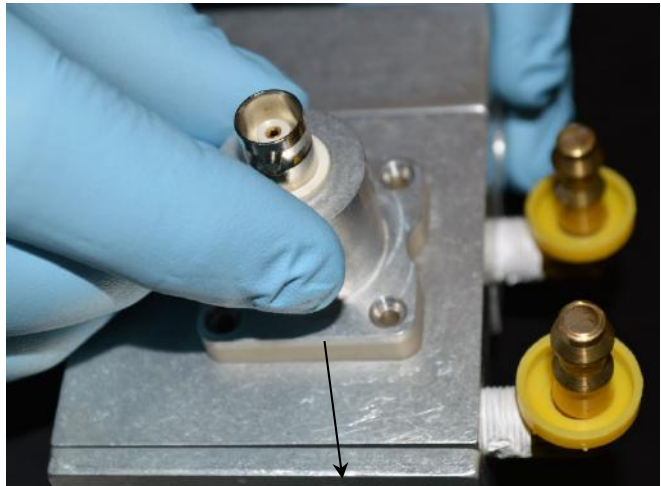

Cell Connections--Quartz Crystal Installation

7. Affix BNC mount to main block with four flat-head screws. Tighten the screws to a snug fit.

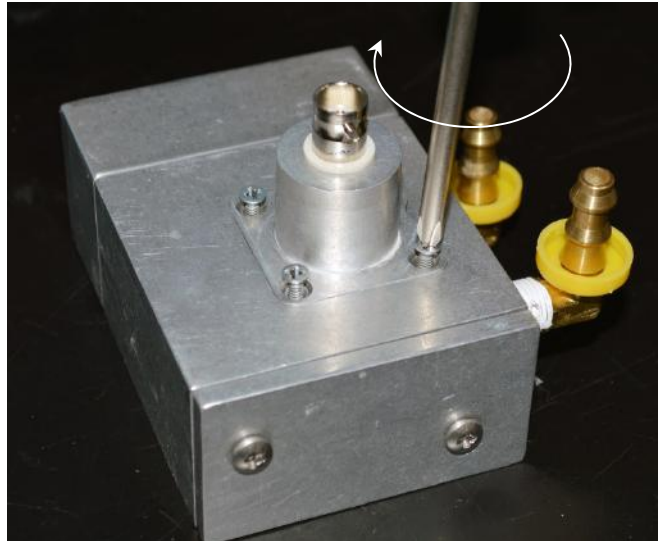

8. Test if the quartz crystal is mounted properly.
 - a. Attach BNC cable to BNC mount.

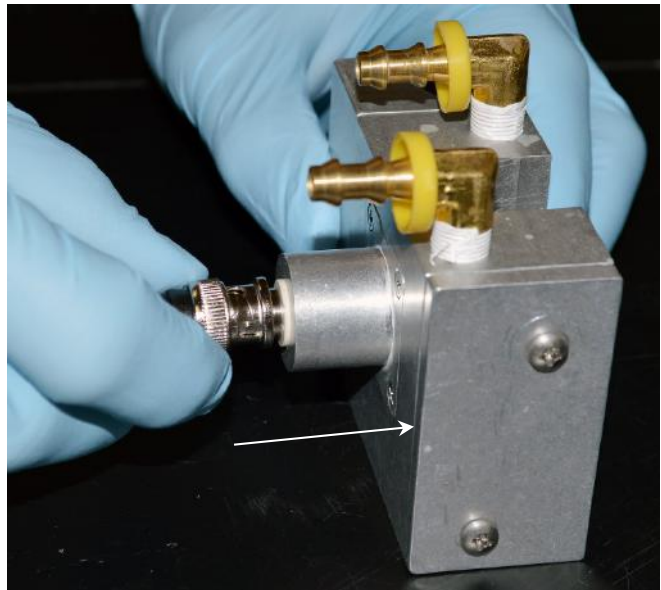

- b. Attach other end of cable to eQCM.
 - c. Switch on eQCM, connect eQCM to host computer, and start Gamry Resonator™ software.
 - d. Click the **Single Scan** button to take a scan.

You may need to zoom in to examine the quality of the spectrum (as shown below).

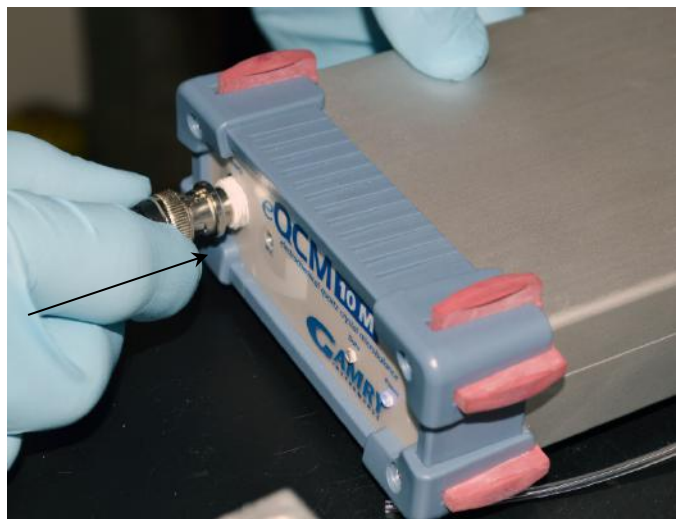

Cell Connections--Quartz Crystal Installation

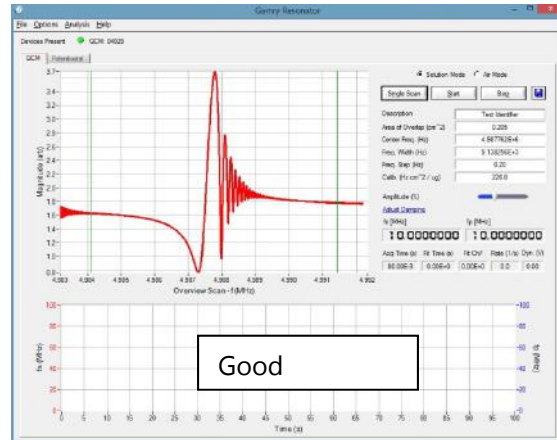
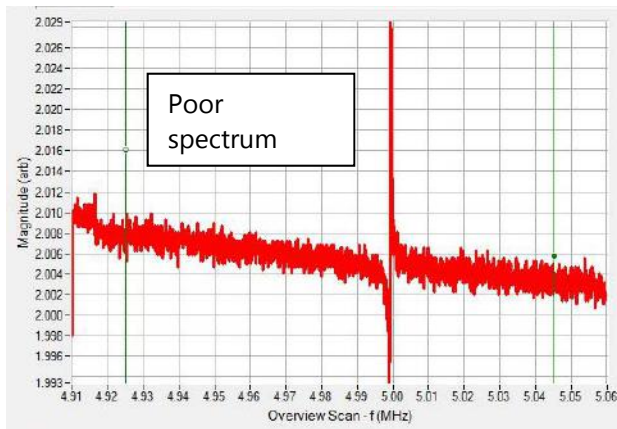

If your spectrum is poor, disconnect the eQCM from the main block and remount the quartz crystal according to steps 5 to 8. If your spectrum is good, continue with the assembly.

9. Attach the static cell.
 - a. Place the O-ring around the side port of the static cell.

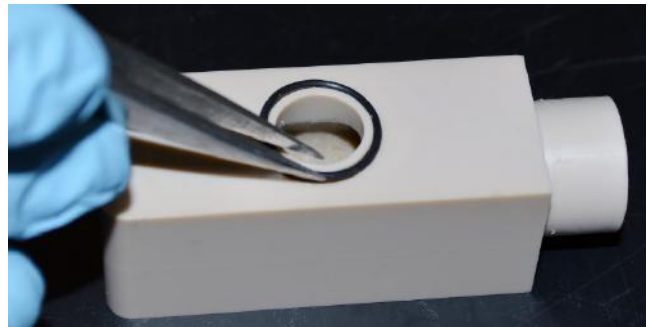

- b. Carefully slide the static cell into the receptacle in the main block.

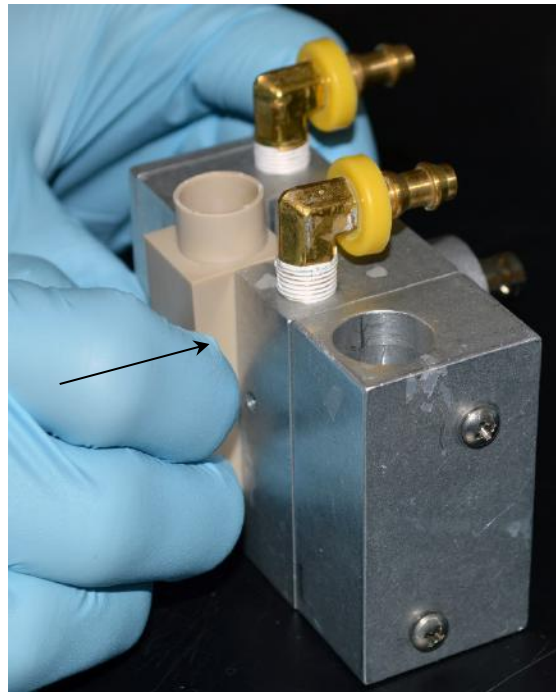

Cell Connections--Quartz Crystal Installation

- c. With two thumbscrews, attach the capture plate to the main block.

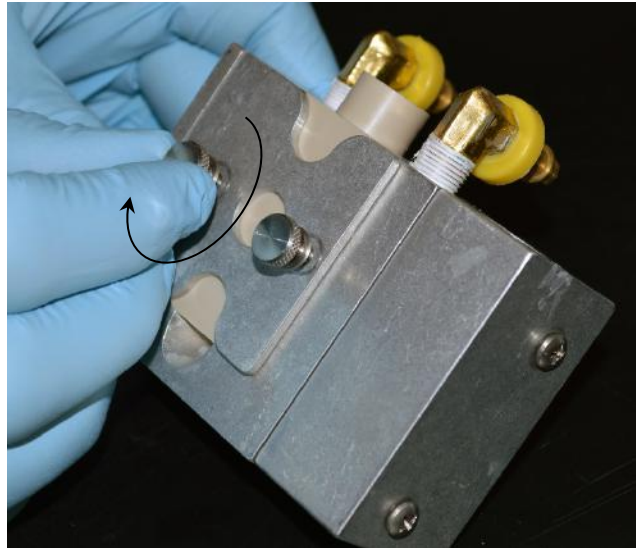

- d. Slide cap onto top of static cell.

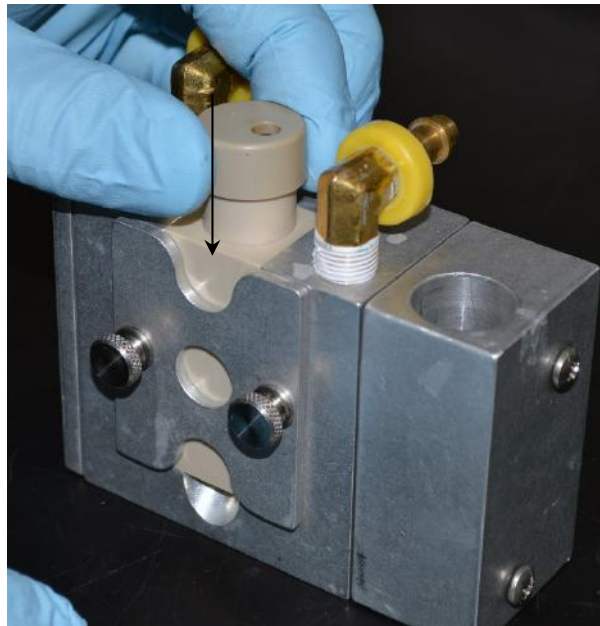

- e. **Optional:** Slide tubing to your temperature-control device onto both brass fittings.

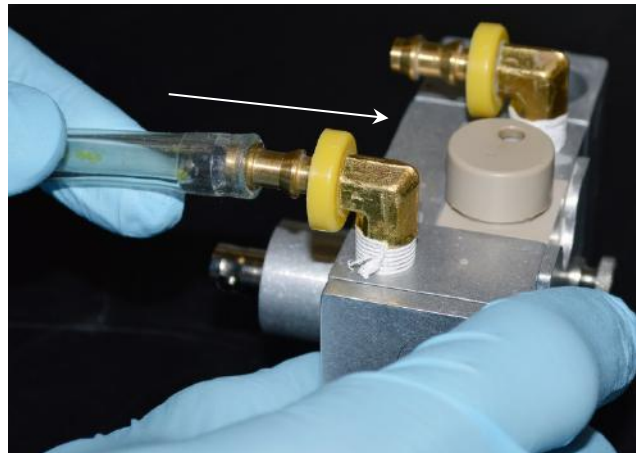

Cell Connections--Quartz Crystal Installation

10. If you have the optional flow cell, assemble the flow cell.
 - a. Place the O-ring around the side port of the flow cell.

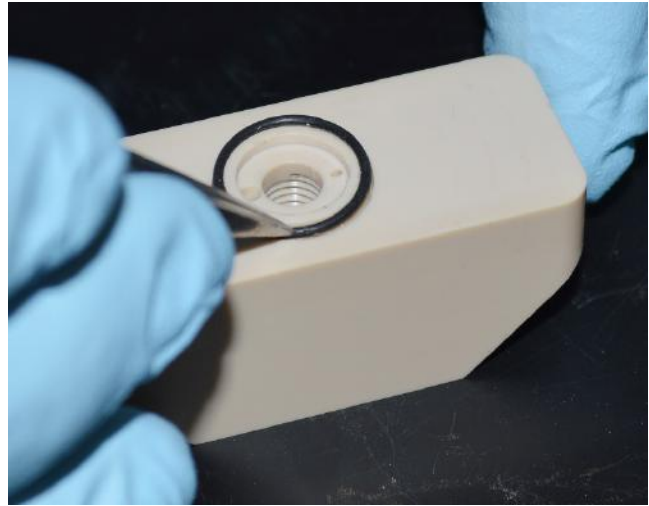

- b. Insert platinum tube into plastic fitting.
If you wish, you may also connect the plastic tubing to the Pt tube, or you may wait until the plastic fitting is mounted onto the main block.

Carefully slide the static cell into the receptacle in the main block.



- c. Slide platinum tube plus plastic fitting into port on flow cell.

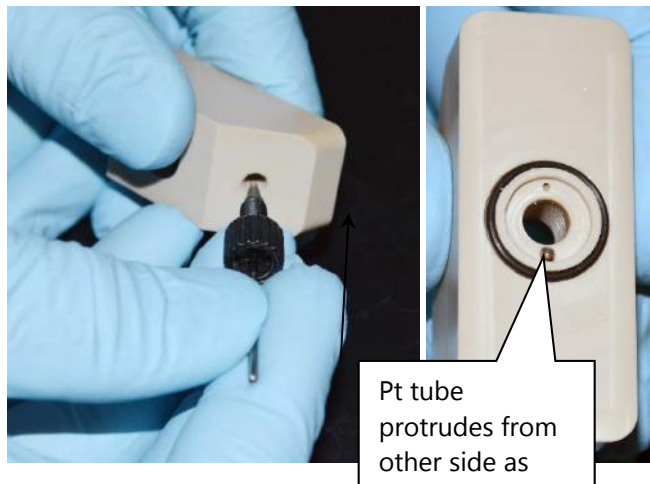

Cell Connections--Quartz Crystal Installation

- d. Insert Teflon[®] tube into other fitting.

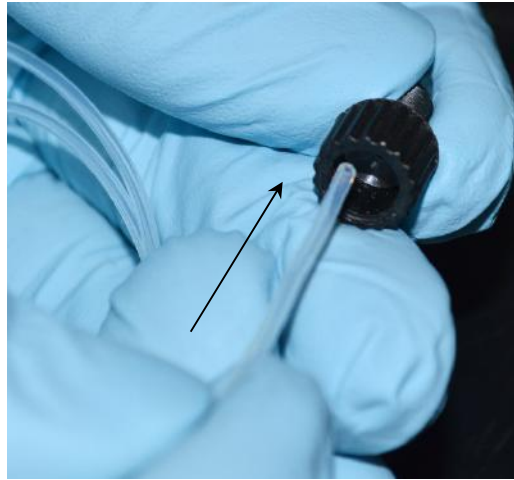

- e. Insert Teflon tube plus fitting into other port on flow cell.



Cell Connections--Quartz Crystal Installation

- f. Slide flow cell into main block.

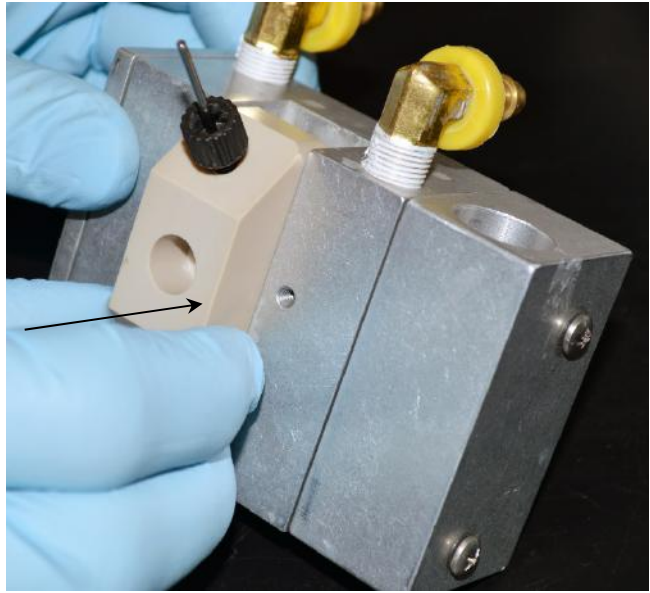

- g. With two thumbscrews, affix capture plate to main block.

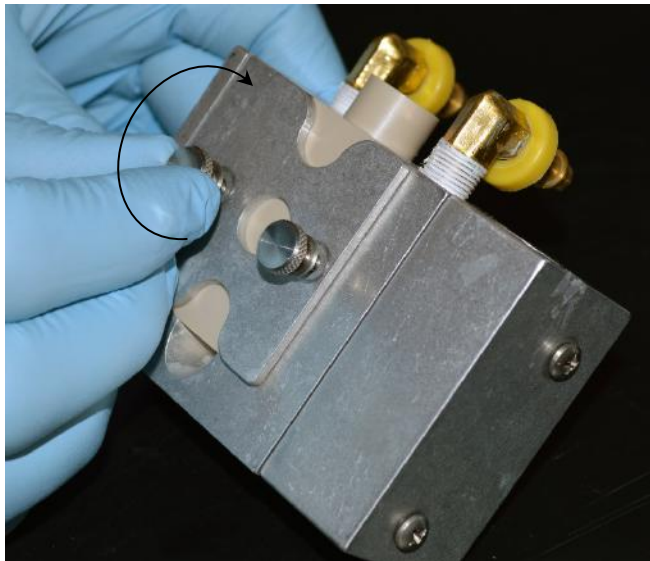

- h. Insert the plastic plug or screw-type reference electrode into the flow module.
For typical QCM flow systems, insert the reference-electrode plug and seal it with an Allen key as shown here.

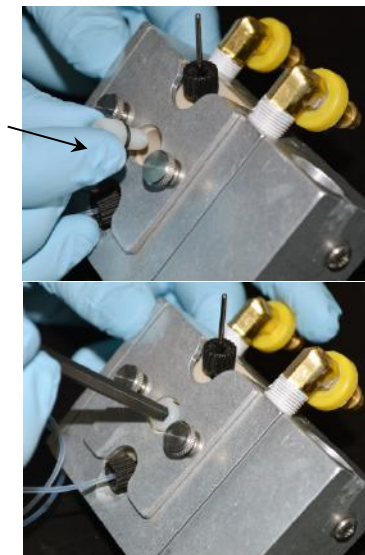

Cell Connections--Quartz Crystal Installation

For eQCM flow systems, insert the connection to a peristaltic pump. The connection is a very snug fit.

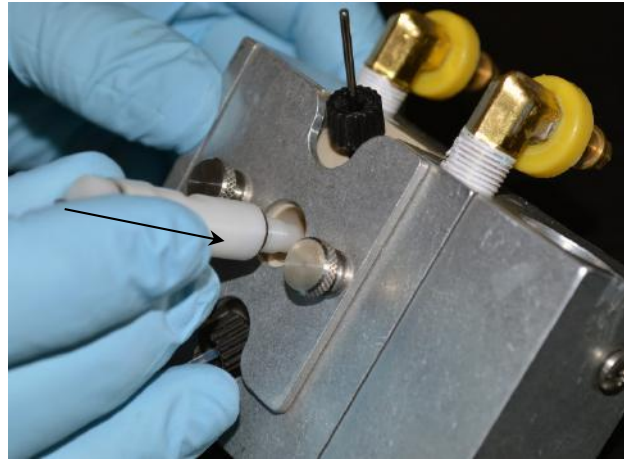

- i. Carefully slide the plastic tubing onto the platinum tube. This can be a very snug fit.



You may also connect the plastic tubing to the Pt tube before the assembly is mounted onto the main block (see



11. Retest if the quartz crystal is mounted properly as shown in step 8. If it is not, you must remove and readjust the quartz crystal.
12. Start any optional temperature-control system and optional flow system. Run your experiment.

Figure 5 - 7
Connection of Working (Green) and Working Sense (Blue) Leads to Crystal



A green Y-shaped cable (part # 985-00128) is included, so you can connect the working electrode of a potentiostat to the quartz crystal. Plug the small, single end of the cable into the **W.E.** jack (see Figure 5.7). Connect the working and working sense leads of your potentiostat to the other ends of this cable.

A binding post on the rear panel of the eQCM 10M is provided for grounding purposes. A water pipe can be a suitable source of earth ground, or an AC mains ground is also suitable.



Warning: Make sure that you make your earth-ground connection to a legitimate source of earth ground. Consult a qualified electrician if you are uncertain how to obtain an earth ground. Connecting the eQCM 10M to an incorrect and unsafe voltage can create a safety hazard (see Chapter 1 for details).

Environmental Considerations

The eQCM 10M is a very sensitive instrument capable of measuring ng/cm^2 of material deposited onto the electrode face. Therefore, special consideration of the environment will help ensure you are acquiring the best data possible. Minimize or eliminate vibrations or sudden movements during data-acquisition.

Likewise, keep temperature fluctuations to a minimum. Changes in temperature and the rate of change of temperature both cause frequency-drift during data-acquisition. If you are planning very long experiments, a temperature-controlled chamber may be necessary to reduce drift. Leaving the crystal holder in solution for some period of time prior to starting your experiment will help reduce unwanted frequency changes.

Chapter 6: Panel Indicators and Connectors

Front Panel

The eQCM 10M front panel includes two connectors and two backlighted LED indicators. Each of these are discussed in turn.

Quartz Connector

The **Quartz** connector is a male BNC-type connector that is used to connect the eQCM 10M to an electrochemical test cell. It is normally used with a Gamry Instruments-supplied cell cable.

Power LED

The **Power** LED normally glows a steady blue when the eQCM 10M is turned on.

When the **Power** LED is off:

- The rear panel power switch is off.
- There is no DC +12 V supply connected to the rear panel **Power** connector.
- The external DC power supply has no input power or is malfunctioning.



The Data LED

The **Data** LED is a green LED that blinks continuously during data-acquisition. Higher data-acquisition rates may make the LED appear lighted continuously.

Rear Panel

The rear panel contains one switch and three connectors.

Power Jack

The eQCM 10M derives all of its power from +12 volts DC input through the **Power** jack. The input current is less than 3 A.

We recommend that you always use the external power supply supplied with your eQCM 10M to supply DC power to the instrument. This supply is rated for operation from 100 to 240 V AC, at frequencies from 50 to 60 Hz. It should therefore be usable worldwide. While an eQCM 10M may work with other power sources, we cannot guarantee it will work to its full specifications.

If you have to use the eQCM 10M with a different supply, make sure that the supply is regulated, has an output between 10 and 14 V, and supplies 2.5 A of load current.



Caution: Power input voltages less than 10 V or greater than 14 V can damage the eQCM 10M.



Power Switch

Normally, the DC Power is connected before the **Power** switch is turned **On**. However, no damage occurs if this switch is already in the **On** position when the **Power** cable is connected, or the AC power input is connected to the external power supply.

GND

The rear panel **GND** connector is intended for one use only, as a chassis ground. See **Error! Reference source not found.**, for safety information concerning this connection. A black banana-plug to banana-plug lead has been provided with your eQCM 10M. You may find it useful when making this earth-ground connection.

USB Port

The **USB** port on the rear panel of the eQCM 10M is a Type B connector as defined in Revision 1.1 and 2.0 of the USB Specification. Use a standard, shielded, Type A/B cable to connect this port to a computer's USB port or a USB hub (preferably an externally powered hub). The two ends of a Type A/B cable are different. The more-rectangular end plugs into the computer and the more-square end plugs into the instrument.

A suitable USB cable was included with your eQCM 10M system. If this cable is lost, you can replace it with a cable from your local computer retailer.

The eQCM 10M is a High Speed USB 2.0 peripheral, capable of data transfer at 480 Mbits/second. If it is plugged into a computer port incapable of High Speed operation it downgrades to USB 1.1 full-speed operation (12 Mbits/second). Obviously data-transfer speed is slower if this occurs.

The eQCM 10M USB port is compatible with Revision 1.1 and 2.0 of the USB specification. It supports the Windows Plug and Play mechanism, including dynamic connect/reconnect.

Chapter 7: eQCM 10M Specifications

All specifications are subject to change without notice.

Frequency Measurement

Range	1–10	MHz
Resolution	0.02	Hz

Environmental

Operating temperature range		0 to 45	°C
Relative humidity	Max	90 (non-condensing)	%
Storage and shipping temperature		–25 to 75	°C
Maximum shipping acceleration		30	G

General

Power input voltage	Range	10 to 14	V
Power	Max	25	W
Dimensions	Max	175 × 115 × 80	m m
Weight	Max	1	kg
Dimensions of external power adapter	Max	120 × 55 × 30	m m
Weight of external power adapter	Max	400	g

Chapter 8: CE Certificate



Redefining Electrochemical Measurement

Declaration of Conformity

According to ISO/IEC Guide 22 and CEN/CENELEC EN 45014

Manufacturer's Name and Location:

Gamry Instruments
734 Louis Drive
Warminster, PA 18974
USA

This declaration is for the Gamry Instruments product models: eQCM 10M.

The declaration is based upon compliance with the following directives:

EMC Standards	Title	Class/ Criteria
EN 61000-4-2	EMC – Electrostatic discharge, Immunity	B
EN 61326	EMC – Radiated Emissions	A
EN 50081-1	Electromagnetic compatibility – interfering emissions – Part 1: Residential areas	
EN 55011	Industrial, scientific, and medical (ISM) radio-frequency equipment – Electromagnetic disturbance characteristics – Limits and methods of measurement (IEC/CISPR 11: 1997, A1: 1999 + A2: 2002)	
EN 55022	Conducted and radiated emission test	B
EN 50082-2	Electromagnetic compatibility – Generic immunity Standard – Part 2: Industrial environment	
EN 61000-4-3	Radiated Field Immunity	A

Low Voltage Directive Safety Standards	Title
EN 61010-1	Safety requirements for electrical equipment for measurement, control and laboratory use, Part 1: General requirements.
EN 61010-2-081	Safety requirements for electrical equipment for measurement, control and laboratory use, Part 2 Particular requirements for automatic and semiautomatic laboratory equipment for analysis and other purposes



 Signature

November 17, 2010
 Date

Dr. Gregory A. Martinchek, PhD
 Title: President

Formal signed declaration is on file at Gamry, Inc.

Chapter 9: Comprehensive Index

985-00124, 2-21
985-00128, 2-31

AC adapter, 0-7

CE Compliance, 0-10
cell cable, 2-21
Chassis Ground binding post, 0-8
cleaning, 0-9
computer, 2-12
computer requirements, 2-16
contract engineering, 0-3
conventions
 notational, 2-12
crystal holder, 2-22, 2-23, 2-32

damage, 0-7, 2-15
Data LED, 2-35
double insulation, 0-7

earth ground, 0-8, 2-31
electrical transients, 0-10
EMC, 0-10
enclosed space, 0-8
environmental limits, 0-9
environmental stress, 0-9

flow cell, 2-27, 2-28, 2-29

GND connector, 2-36
ground binding post, 0-8

Help system, 2-12

inspection, 0-7
installation, 2-15
internal temperature, 2-16

O-ring, 2-22, 2-25, 2-27

peristaltic pump, 2-30
physical location, 2-16
platinum tube, 2-27, 2-30
Plug & Play, 2-16
power brick, 0-7
Power Brick, 0-7
Power cable, 2-36

Power Connection, 2-16
Power connector, 2-35
Power Cord, 2-16
Power jack, 2-36
Power LED, 2-18, 2-35
power line transient, 0-10
Power switch, 2-18, 2-36

Quartz connector, 2-35
quartz crystal, 2-12, 2-13, 2-23, 2-24, 2-25, 2-30,
 2-31
quartz crystal installation, 2-21

radio frequency, 0-10
reference electrode, 2-29
Resonator™ software, 2-24

safety, 0-7
schematic, 2-13
service, 0-9
service contract, 0-3
shielding against noise, 0-8
Single Scan button, 2-24
static cell, 2-25, 2-26, 2-27
static electricity, 0-10
support, 0-3

Teflon, 0-4
Teflon® tube, 2-28
telephone assistance, 0-3

USB cable, 2-19
USB port, 2-16, 2-19, 2-36, 2-37

W.E. jack, 2-31
Warranty, 0-3
Windows, 0-3, 0-4, 2-12, 2-16, 2-19, 2-37
working electrode, 2-31
 14.