



eQCM 15M™

Electrochemical Quartz Crystal Microbalance

Operator's Manual



If You Have Problems

Please visit our service and support page at <https://www.gamry.com/support-2/>. This page contains information on installation, software updates, and training. It also contains links to the latest available documentation. If you are unable to locate the information you need from our website, you can contact us via email using the link provided on our website. Alternatively, you can contact us one of the following ways:

Internet	https://www.gamry.com/support-2/
Telephone	(215) 682-9330 9:00 AM–5:00 PM US Eastern Standard Time (877) 367-4267 Toll-free US & Canada Only

Please have your instrument model and serial numbers available, as well as any applicable software and firmware revisions.

If you have problems with installation or use of a system containing an eQCM 15M, please call from a phone next to your computer, where you can type and read the screen while talking to us.

We will be happy to provide a reasonable level of free support for registered users of the eQCM 15M. Reasonable support includes telephone assistance covering the normal installation, use and simple customization of a computerized system containing an eQCM 15M connected to a Windows®-compatible computer.

A service contract that extends both the hardware warranty and software update period is available at an additional charge. Software updates *do not* include software enhancements offered to our customers at additional cost.

Enhancements to the eQCM 15M and Gamry's standard applications software that require significant engineering time on our part can be performed on a contract basis. Contact us with your requirements.

Limited Warranty

Gamry Instruments, Inc. warrants to the original user of this product that it shall be free of defects resulting from faulty manufacture of the product or its components for a period of two years from the original shipment date of your purchase.

Gamry Instruments, Inc. makes no warranties regarding either the satisfactory performance of the eQCM 15M including the software provided with this product or the fitness of the product for any particular purpose. The remedy for breach of this Limited Warranty shall be limited solely to repair or replacement, as determined by Gamry Instruments, Inc., and shall not include other damages.

Gamry Instruments, Inc. reserves the right to make revisions to the system at any time without incurring any obligation to install same on systems previously purchased. All system specifications are subject to change without notice.

There are no warranties which extend beyond the description herein. This warranty is in lieu of, and excludes any and all other warranties or representations, expressed, implied or statutory, including merchantability and fitness, as well as any and all other obligations or liabilities of Gamry Instruments, Inc; including but not limited to, special or consequential damages.

This Limited Warranty gives you specific legal rights and you may have others, which vary from state to state. Some states do not allow for the exclusion of incidental or consequential damages.

No person, firm or corporation is authorized to assume for Gamry Instruments, Inc., any additional obligation or liability not expressly provided herein except in writing duly executed by an officer of Gamry Instruments, Inc.

Disclaimers

Gamry Instruments, Inc. cannot guarantee that the eQCM 15M will work with all computer systems, operating systems, or third-party hardware/software.

The information in this manual has been carefully checked and is believed to be accurate as of the time of printing. However, Gamry Instruments, Inc. assumes no responsibility for errors that might appear.

Copyrights

eQCM 15M™ Electrochemical Quartz Crystal Microbalance Operator's Manual copyright © 2023, Gamry Instruments, Inc., all rights reserved.

Gamry Framework copyright © 1989–2023, Gamry Instruments, Inc., all rights reserved.

Interface 1010™, Interface 5000™, Interface Power Hub™, EIS Box™ 5000, Reference 620™, Reference 3000™, Reference 3000AE™, Reference 30K™, LPI1010™, eQCM 15M™, IMX8™, Gamry Framework™, Faraday Shield™, and Gamry™ are trademarks of Gamry Instruments, Inc.

Windows® is a registered trademark of Microsoft Corporation.

No part of this document may be copied or reproduced in any form without the prior written consent of Gamry Instruments, Inc.

Table of Contents

If You Have Problems	3
Limited Warranty.....	3
Disclaimers	4
Copyrights	4
Table of Contents.....	5
Chapter 1: Safety Considerations	7
Inspection	7
Product Safety.....	7
Grounding in the eQCM 15M.....	7
Temperature and Ventilation.....	8
Defects and Abnormal Stresses	8
Environmental Limits.....	9
Cleaning	9
Service.....	9
Emission Warning	9
Electrical Transient Sensitivity	10
CE Compliance	10
RoHS Compliance.....	10
Chapter 2: Introduction	11
About this Manual.....	11
About the eQCM 15M.....	11
Notational Conventions.....	11
Chapter 3: Instrument Circuitry.....	13
eQCM 15M Schematic/Block Diagram	13
Chapter 4: Installation.....	15
Initial Visual Inspection	15
Physical Location	15
Computer Requirements	16
Plug & Play System Configuration	16
USB and Power Connection.....	16
Power-Up Test.....	17
First-time Device Installation in Windows®	18
Chapter 5: Cell Connections	19
Normal Cell Connections	19
Quartz Crystal Installation	19
Environmental Considerations	29
Chapter 6: Panel Indicators and Connectors.....	31
Front Panel	31
Quartz Connector	31
Working Electrode Connectors	31
Power LED.....	31
USB LED.....	31
Rear Panel	32
USB Port.....	32
GND.....	32
Appendix A: eQCM 15M Specifications	33

Table of Contents

Frequency Characteristics..... 33
General..... 33
Environmental..... 33
Appendix B: Certifications..... 35
 Declaration of Conformity: No. DOC-2023-CE-eQCM15M..... 35
 Certificate of Conformance 36
 Declaration of Conformity: No. DOC-2023-UKCA-eQCM15M 37
Appendix C: Comprehensive Index..... 39

Chapter 1: Safety Considerations

Your eQCM 15M is supplied in a safe condition. This chapter of the eQCM 15M Operator's Manual contains some information and warnings that you must follow to insure continued safe operation of the eQCM 15M.

Inspection

When you receive your eQCM 15M Electrochemical Quartz Crystal Microbalance, inspect it for evidence of shipping damage. If you note any damage, please notify Gamry Instruments Inc. and the shipping carrier immediately. Save the shipping container for possible inspection by the carrier.



Warning: An eQCM 15M damaged in shipment can be a safety hazard. Do not operate damaged apparatus until a qualified service technician has verified its safety. Tag a damaged eQCM 15M to indicate that it could be a safety hazard.

Product Safety

The eQCM 15M has been designed, tested, and certified to meet the requirements of EN 61010, *Safety requirements for electrical equipment for measurement, control, and laboratory use*. As defined in this standard, it is a Category I apparatus, designed for connection to circuits other than the power mains.

The instrument contains no internal circuitry that is at "hazardous live" voltages as defined in EN 61010 (the standard mentioned above).

The eQCM 15M requires a minimum voltage of 5 V for operation.

The provided USB-A to USB-C cable is specified for a higher current rating (max. 2 A) to ensure that the eQCM 15M is provided with enough power.



Warning: Use only Gamry-approved USB-A to USB-C cables with your eQCM 15M. Other cables may alter the performance and/or safety characteristics of the eQCM 15M.

Grounding in the eQCM 15M

A Chassis Ground binding post on the rear panel of the eQCM 15M is provided for a connection to earth ground. Simply run a wire from this binding post to a suitable source of earth ground. A black 1.2-m wire is provided to ease this connection.



Sources of earth ground include:

- Most metal water pipes,
- the chassis of **most** electronic apparatus (which are generally earth-grounded), and
- the protective ground terminal of an AC mains power plug.

We recommend that you discuss grounding with an electrical or electronics professional prior to making this earth-ground connection.

Note that this connection of the instrument to an earth ground is not a “Protective Earth Ground” as defined in EN 61010.

This binding post is not intended for any use other than connecting the eQCM 15M to an earth ground to improve shielding against noise. Connecting this binding post to a hazardous voltage can create a significant safety hazard.



Warning: Do not connect the chassis-ground binding post to any voltage other than earth ground. An improper connection can create a safety hazard, which could result in personal injury or death.

Temperature and Ventilation

Your eQCM 15M Electrochemical Quartz Crystal Microbalance was designed for indoor use at ambient temperatures between 0°C and 45°C.



Caution: Do not block the airflow around the instrument chassis. While the circuitry should suffer no damage due to excessive heat, the enclosure may become uncomfortably hot to the touch with insufficient air flow around the chassis.

Be careful when operating the instrument in an enclosed space (such as an enclosed relay rack or NEMA enclosure). The temperature within the enclosure must not exceed 45°C. You may need to provide ventilation holes or even forced air-cooling for the enclosed space if excessive temperature rise occurs.

Defects and Abnormal Stresses

Treat your eQCM 15M as potentially hazardous if any of the following is true of the unit:

- It shows visible damage,
- It does not operate properly,
- It has been stored for a long period of time under unfavorable conditions,
- It has been dropped or subjected to severe transport stress,
- It has been subjected to environmental stress (corrosive atmosphere, fire, etc.).

Safety Considerations

Do not use your eQCM 15M or any other apparatus if you think it could be hazardous. Have it checked by qualified service personnel.

Environmental Limits

There are environmental-limit conditions on the storage, shipping, and operation of this equipment. The eQCM 15M is **not** designed for outdoor use.

Storage	Ambient Temperature	-25°C to 75°C
	Relative Humidity	Maximum 90% non-condensing
Shipping	Ambient Temperature	-25°C to 75°C
	Acceleration	Maximum 30 G
Operation	Ambient Temperature	0°C to 45°C
	Relative Humidity	Maximum 90% non-condensing



Warning: This instrument is not designed for operation in conditions where liquid water may enter the chassis, or water vapor may condense within the chassis. Operation of an eQCM 15M that has water within the chassis can create a safety hazard, which could result in personal injury or death.

Cleaning

Disconnect the eQCM 15M from all power sources prior to cleaning.

Use a cloth *lightly* dampened with either clean water or water containing a mild detergent to clean the outside of the eQCM 15M enclosure. Alternatively, you can use isopropyl alcohol. Do not use a wet rag or allow fluid to enter the eQCM 15M enclosure. Do not immerse the eQCM 15M in any type of cleaning fluid (including water). Do not use any abrasive cleaners.

Service

Your eQCM 15M Electrochemical Quartz Crystal Microbalance has no user-serviceable parts inside. Refer all service to a qualified service technician.



Warning: Never operate eQCM 15M with any cover or panel on the chassis open. Always remove the power connection before opening the eQCM 15M case.

Emission Warning

Your eQCM 15M generates, uses, and can radiate radio-frequency energy. The radiated levels are low enough that the eQCM 15M should not create an interference problem in most industrial laboratory environments.

The eQCM 15M has been tested for radiated RF interference and has been found to be in compliance with EN 61000-4-3.

Electrical Transient Sensitivity

Your eQCM 15M Electrochemical Quartz Crystal Microbalance was designed to offer reasonable immunity from electrical transients, including transients on the incoming USB supply and Electrostatic Discharge.

The eQCM 15M is not rated for continuous use when subject to ESD events. It should suffer no permanent damage when subject to the standard ESD events defined in EN61000-4-2 but may cease normal operation until it is switched off and restarted.

In rare cases, the instrument could malfunction as a result of severe electrical transients such as a static discharge. If you are having problems in this regard, the following steps may help:

If the problem is static electricity (sparks are apparent when you touch the eQCM 15M or its cables):

- Placing your eQCM 15M on a static-control work surface may help. Static-control work surfaces are now generally available from computer-supply houses and electronics-tool suppliers. An antistatic floor mat may also help, particularly if a carpet is involved in generating static electricity.
- Air ionizers or even simple air humidifiers can reduce the voltage available in static discharges.

If the problem is AC power-line transients (often from large electrical motors near the eQCM 15M):

- Try plugging your eQCM 15M into a different USB-port.
- Move your eQCM 15M away from any interfering source.

Contact Gamry Instruments, Inc. if these measures do not solve the problem.

CE Compliance

The European Community has instituted standards limiting radio-frequency interference from electronic devices and mandating several safety requirements. Gamry Instruments, Inc. has designed the eQCM 15M Electrochemical Quartz Crystal Microbalance to comply with these standards.

The relevant CE regulations include EN 61326-1:2013.

RoHS Compliance

The eQCM 15M Electrochemical Quartz Crystal Microbalance has been built using lead-free components and lead-free solder. It is in compliance with the European RoHS initiative.

Chapter 2: Introduction

About this Manual

This manual covers the installation, safety, and use of the Gamry Instruments eQCM 15M Electrochemical Quartz Crystal Microbalance.

This manual describes use of an eQCM 15M with Revision 7.9 (and later revisions) of the Gamry Framework software. It is equally useful when setting up a newly purchased instrument or modifying the setup of an older instrument for use with new software.

Chapter 1 includes an in-depth discussion of safety issues. This chapter describes this manual and gives a brief overview of the eQCM 15M features. Chapter 3 is a description of the electronic circuitry in the eQCM 15M. Chapter 4 contains installation instructions. Chapter 5 describes inserting a crystal into a holder and connecting the holder to the eQCM 15M, and Chapter 6 describes the eQCM 15M's front and rear panels. Specifications are in Chapter 7.

This manual does not discuss software installation or software operation in any detail.

Software support for the eQCM 15M is described in the Gamry's online Help system and associated documentation.

About the eQCM 15M

The eQCM 15M is a research-grade electrochemical instrument packaged in a small, easy-to-handle case. It offers measurement capabilities similar to instruments that are more than ten times its size and weight, and more than two times its price. The instrument can operate as a stand-alone quartz-crystal microbalance or with a potentiostat.

eQCM 15M features include:

- 1–15 MHz operating range with no need to send the unit back to the factory in order to recalibrate for different frequency crystals
- DC-decoupled output for interface with a potentiostat
- 0.02 Hz resolution
- Reporting of both the series and parallel resonance frequencies
- An insulated USB connection avoiding ground loops

The eQCM 15M requires a host computer for its use. Unlike some other quartz crystal microbalances, the instrument connects to the computer through a USB cable. Both powering the eQCM 15M as well as data transfer are realized using this USB connection.

Notational Conventions

In order to make this manual more readable we have adopted some notational conventions. These are used throughout this manual and all other Gamry Instruments manuals:

- Numbered lists. A numbered list is reserved for step-by-step procedures, with the steps always performed sequentially.
- Bulleted list. The items in a bulleted list, such as this one, are grouped together because they represent similar items. The order of items in the list is not critical.
- File names and folders. Inside paragraphs, references to computer files and Windows® folders are capitalized and placed within quotes, for example: "C:\MYGAMRYDATA\EQCM.DTA" and "GAMRY.INI".

Chapter 3: Instrument Circuitry

eQCM 15M Schematic/Block Diagram

If you are not familiar with electronic schematics or quartz crystal microbalances, you probably want to skip this chapter. This information is for expert use only and is not required for routine use of the instrument.

The following figure is part schematic diagram and part block diagram. They are intended to show the basic principles of the instrument without the confusion of the full circuitry details.

The schematic/block diagram figure shows the quartz-crystal microbalance board.

Figure 3-1
eQCM15M Impedance Scanning Quartz Crystal Microbalance board,
simplified schematic/block diagram

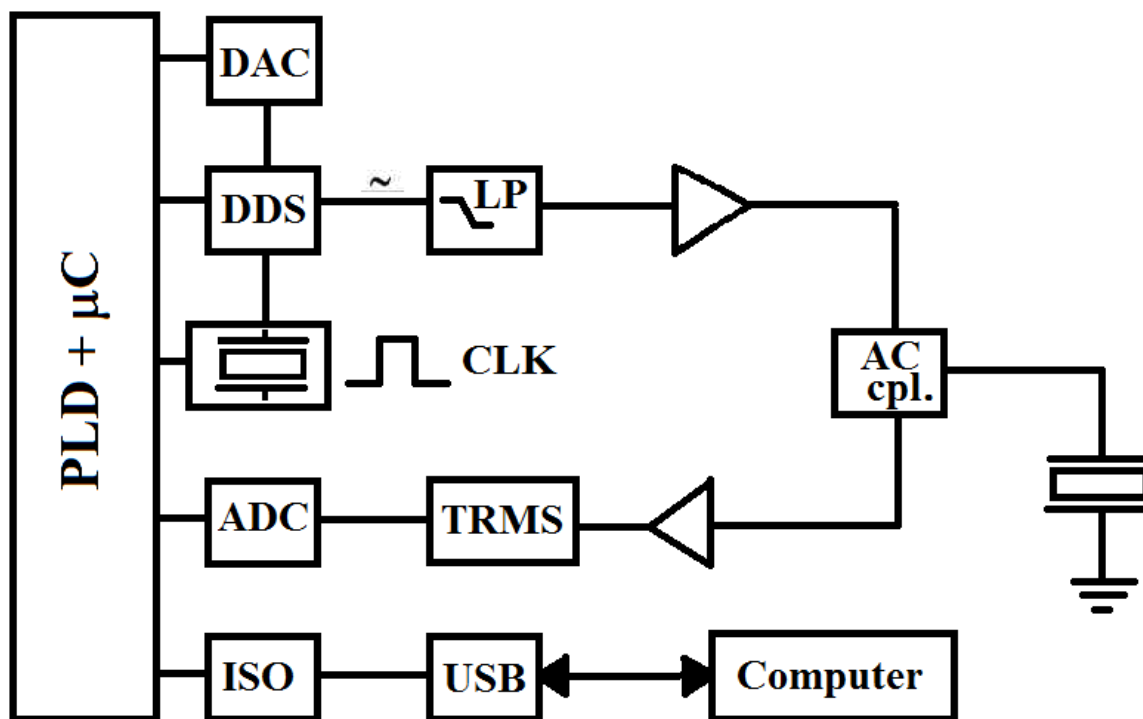

Notes for Figure 3-1:

- The programmable logic device (PLD) acts as the core of the QCM. Sine waves of varying frequencies and amplitude are generated by the DDS, in 4096 steps from 0.05 to 8.33 V_{rms} . The PLD and DDS are driven by the same primary 80 MHz clock (CLK).
- Output from the DDS is filtered through a 4th-order low-pass filter (LP) with a cut-off range of 15 MHz. This signal is amplified by a high-speed operational amplifier. The amplified signal is passed through the AC coupler (AC cpl.) and injected into the quartz crystal.
- The coupler allows integration to a potentiostat for electrochemical studies. The output signal from the crystal is coupled out by the same network. The signal is then passed through an RMS-to-DC (TRMS) converter and evaluated by an A/D-converter (ADC).
- The PLD then performs some low-level mathematical functions and delivers the data to a ground-isolated (ISO) USB interface (USB).

Chapter 4: Installation

This chapter of the eQCM 15M Operator's Manual covers normal installation of the instrument.

These instructions assume use with Gamry's Framework Software Revision 7.9 or higher.

Figure 4-1
Front View of an eQCM 15M



Initial Visual Inspection

After you remove your eQCM 15M from its shipping carton, check it for any signs of shipping damage. If you find any damage, please notify Gamry Instruments, Inc., and the shipping carrier immediately. Save the shipping container for possible inspection by the carrier.



Warning: Do not operate damaged apparatus until a qualified service technician has verified its safety. Tag a damaged eQCM 15M to indicate that it could be a safety hazard.



Caution: If the eQCM 15M is taken from a cold location (for example, outdoors in winter conditions) to a warm, humid location, water vapor could condense on the cold surfaces inside the instrument, possibly creating a hazardous condition. Before connecting power to a "cold" eQCM 15M, allow at least one hour for the instrument to warm up to room temperature.

Physical Location

Place your eQCM 15M on a flat workbench surface. You need access to the rear of the instrument because some cable connections are made from the rear. The eQCM 15M is generally operated in a horizontal position (see Figure 4-1). Operation in other positions is possible as long as you ensure that air movement around the chassis is not restricted.



Caution: Do not block the airflow around the chassis. While the circuitry should suffer no damage due to excessive heat, the enclosure may become uncomfortably hot to the touch if no air flows around the chassis. Running the instrument without adequate cooling could shorten the time to failure of some of the circuitry.

If you place your eQCM 15M within an enclosed space, make sure that the temperature within that space does not exceed the 45°C ambient temperature limit of the eQCM 15M. Be particularly careful if a computer or other heat-dissipating equipment is mounted in the same enclosure as the eQCM 15M.

The eQCM 15M has not been designed for outdoor use.

Computer Requirements

Before you connect an eQCM 15M to a host computer, you must ensure that your computer meets these simple requirements:

- A computer based on one of the x86 family of Intel™ microprocessors or a 100%-compatible processor from another vendor.
- Microsoft Windows® 10 or newer is required with Gamry Framework™ software version 7.9.1 and above. Only the 64-bit version of these operating systems is supported.
- A USB port that supports Full Speed (12 Mbits/second) or High Speed (480 Mbits/second) USB transfers. It must be compatible with Revision 1.1 or Revision 2.0 of the USB specification.

Plug & Play System Configuration

The eQCM 15M is completely compatible with the Windows Plug & Play configuration system. Like most Plug & Play hardware, it is best if you install the software for the eQCM 15M **before** you install the hardware.

The latest Gamry software is not provided on a DVD anymore but is now available for download as *.exe or *.iso file on Gamry Instruments' Client Portal after creating an account and registering your instrument:

<https://www.gamry.com/client-portal/my-account/>

Note: Verify that the Resonator software is added to the list of programs that are installed.

USB and Power Connection

The eQCM 15M connects to the computer using a High Speed USB cable. Both data transfer as well as powering the eQCM 15M are done via this connection. There is no need for an additional power supply to be connected.

To accommodate different computer setups, two different USB cables and a powered USB hub are shipped with your instrument. You can get a replacement at Gamry Instruments if a part is lost. Contact your local Gamry Representative or e-mail to techsupport@gamry.com if you experience problems.

If your computer already has a USB-C input, we recommend using the provided USB-C (M) to USB-C (M) cable with Gamry P/N 985-00234. Connect one end to the **USB** port on the eQCM 15M rear panel (see Figure 4-2) and the other end to your computer.

If no USB-C input is available, use the provided USB-C (M) to USB-A (M) cable with Gamry P/N 985-00235. Again, connect the smaller USB-C plug into the **USB** port of the eQCM 15M on the rear panel. Connect the larger USB-A plug into a USB3.0 input of your computer. If none is available, use the included powered USB-hub (Gamry P/N 950-00101). It comes with a universal power adapter for general use.



Standard USB1.0 or 2.0 (type A) inputs on your computer do not provide enough power to power up your eQCM 15M. Only USB3.0 inputs provide at least 0.9A/4.5W power. Use the powered USB-hub if your computer has no USB3.0 input, otherwise your eQCM 15M cannot be powered.

Only this USB-type provides enough power

An A/C USB cable has different connectors on each end. The end with a wider, rectangular-shaped connector (type A) plugs either directly into a USB port on your computer or you can plug it into a power USB-hub that is connected to the computer. The end with a smaller connector (type C) plugs into the **USB** port on the eQCM 15M (see Figure 4-2).

Figure 4-2
Rear Panel of the eQCM 15M with USB connection



You can also safely remove the USB cable without powering down the eQCM 15M and your computer. However, be aware that this may have undesirable consequences if the system is currently taking data or performing an electrochemical experiment.

Power-Up Test

Before you make any other connections to your eQCM 15M, check that the instrument is at least nominally functional.

One quick test is to turn on the eQCM 15M and watch the blue **Power** LED indicator on the front panel. After connecting DC power to the instrument, turn press the **Power** button.



The **Power** LED should illuminate and remain on. The status of the other LED indicator is not important at this time.



Caution: If the Power LED goes on, then turns off and does not come on, the eQCM 15M is not working properly! Contact Gamry Instruments or your local Gamry Instruments representative as soon as possible if this power up test fails.

First-time Device Installation in Windows®



These instructions presume you have already installed Gamry software Revision 7.10 or higher.

Chapter 5: Cell Connections

Normal Cell Connections

Each eQCM 15M is shipped with a standard, shielded BNC cable terminated with a ceramic adapter (P/N 985-00124). Attach the male end of the cable to the front panel of the eQCM 15M (see Figure 5-1).

Figure 5-1
Connection of the BNC Cable to the Quartz



Quartz Crystal Installation

This section describes how to mount a quartz crystal in a Temperature Controlled QCM Cell (990-00400) and shows the general assembly procedure for this cell type.

1. Attach vial-side plate to main block with two long screws. Tighten to snug-fit.

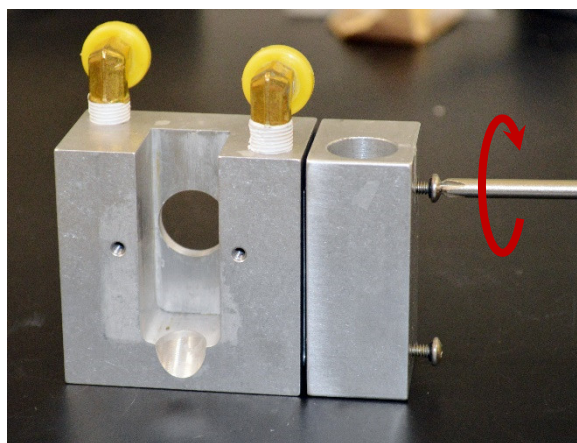

2. Attach side plate to main block with two short screws. Tighten to snug-fit.

Cell Connections

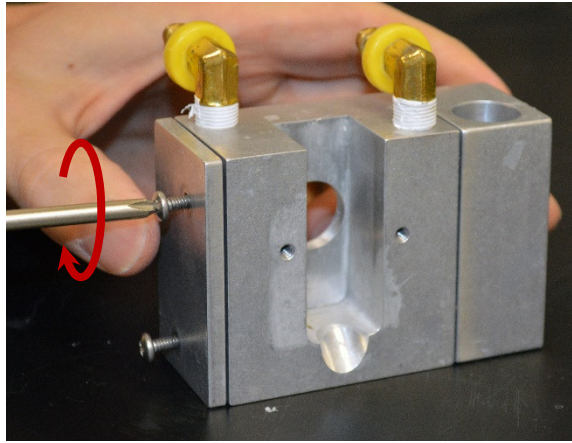

3. Press PEEK crystal holder into main block.

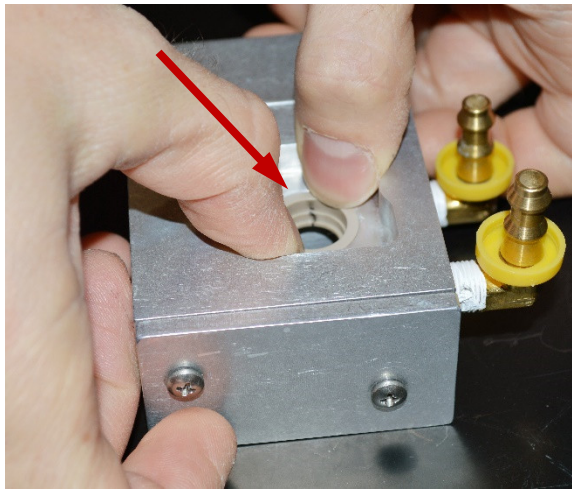

4. Carefully place O-ring into mounted crystal holder.

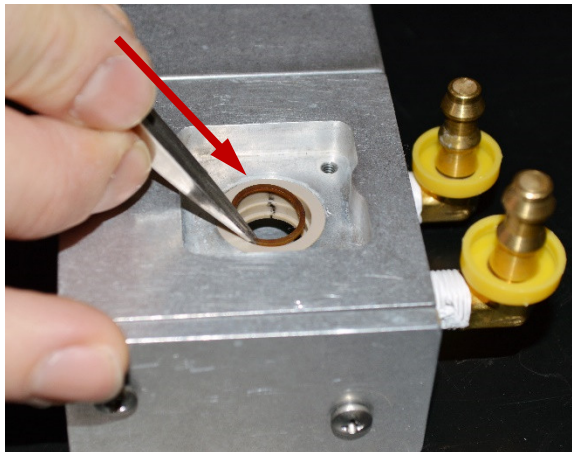

5. Using tweezers, carefully place quartz crystal into crystal holder.

Cell Connections

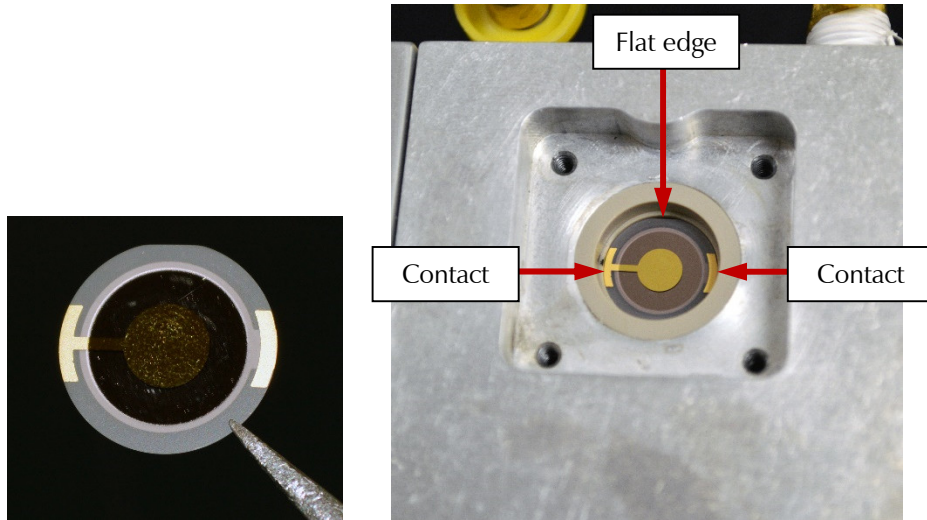

Note orientation of crystal: The flat edge MUST be at the top (12 o'clock position) and the two electrical contacts MUST be at the left and right (3 o'clock and 9 o'clock positions).

6. Press-fit BNC mount into main block, until it is flush with the exterior surface.

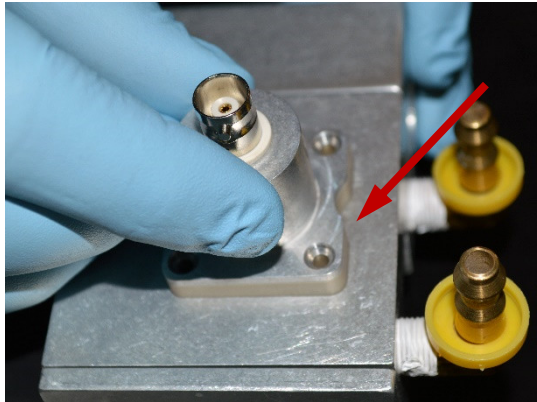

7. Affix BNC mount to main block with four flat-head screws. Tighten the screws to a snug fit.

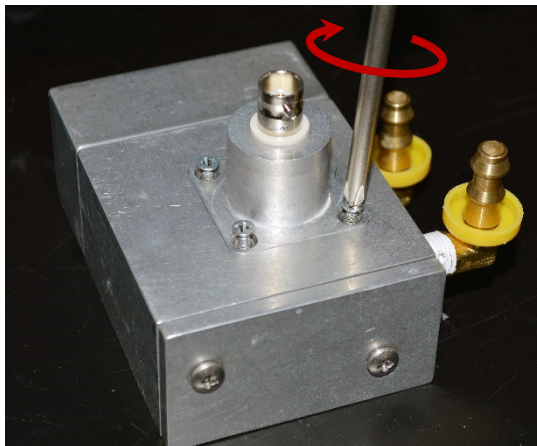

Cell Connections

8. Test if the quartz crystal is mounted properly.
 - a. Attach BNC cable to BNC mount.

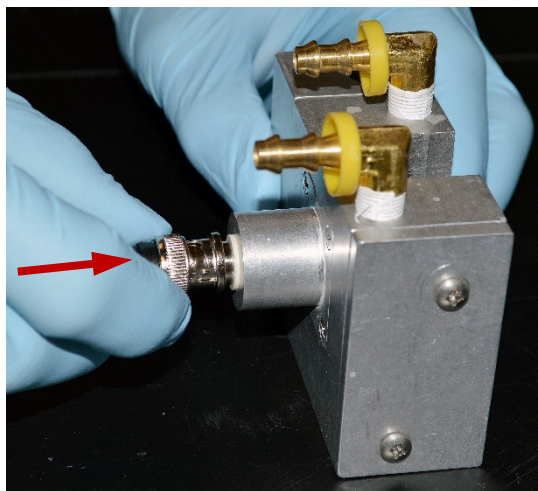

- b. Attach other end of the cable to the eQCM.



- c. Switch on the eQCM, connect it to host computer, and start the Gamry Resonator™ software.
 - d. Click the **Single Scan** button to take a scan.

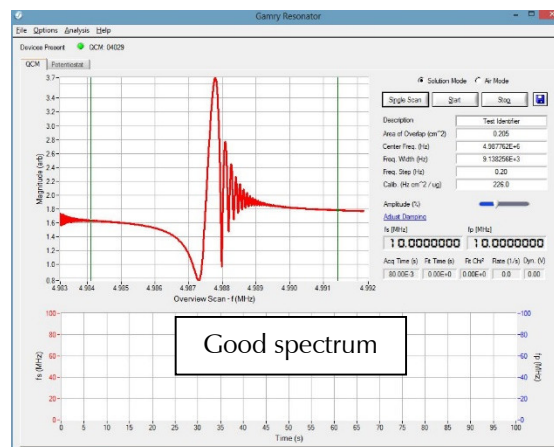
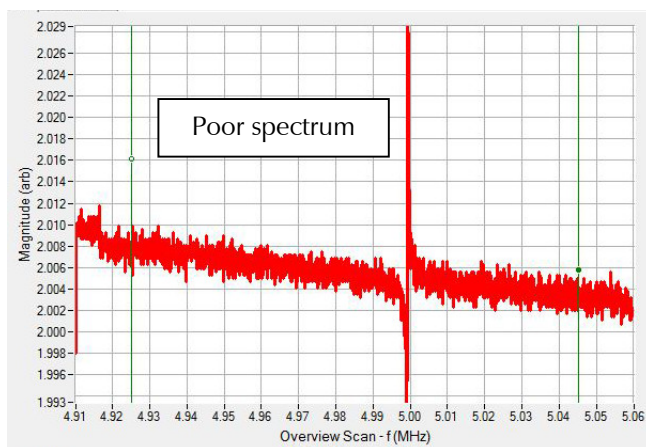

Cell Connections

- e. You may need to zoom in to examine the quality of the spectrum. If your spectrum is poor, disconnect the eQCM 15M from the main block and remount the quartz crystal according to steps 5 to 8. If your spectrum is good, continue with the assembly.
9. Attach the static cell.
 - a. Place the O-ring around the side port of the static cell.

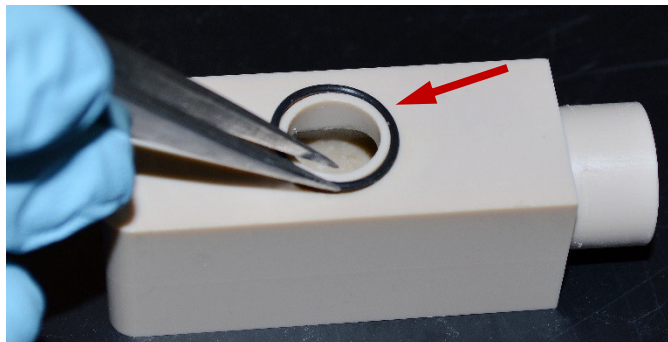

- b. Carefully slide the static cell into the receptacle of the main block.

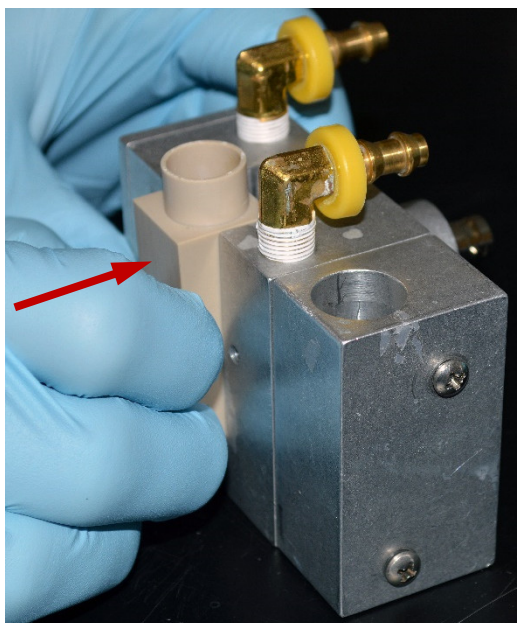

- c. With two thumbscrews, attach the capture plate to the main block.

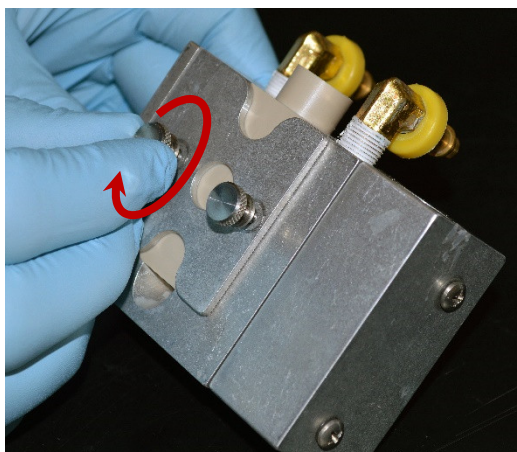

Cell Connections

- d. Slide cap onto top of static cell.

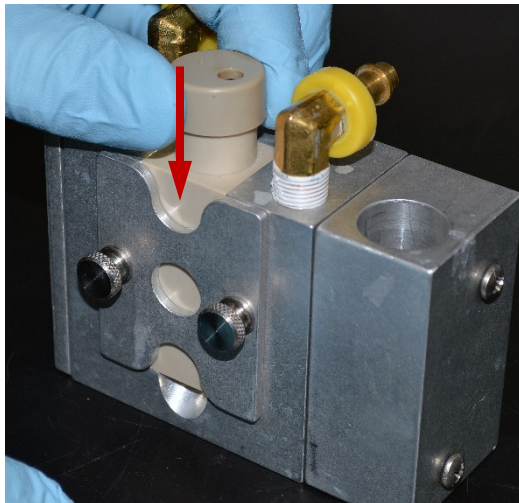

- e. **Optional:** Slide tubing to your temperature-control device onto both brass fittings.

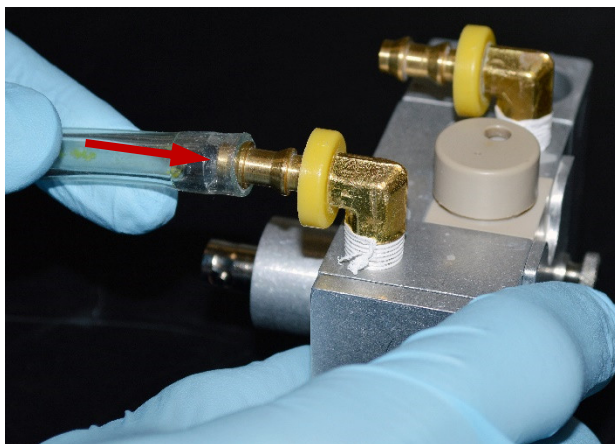

10. If you have the optional flow cell (990-00402), assemble the flow cell.

- a. Place the O-ring around the side port of the flow cell.

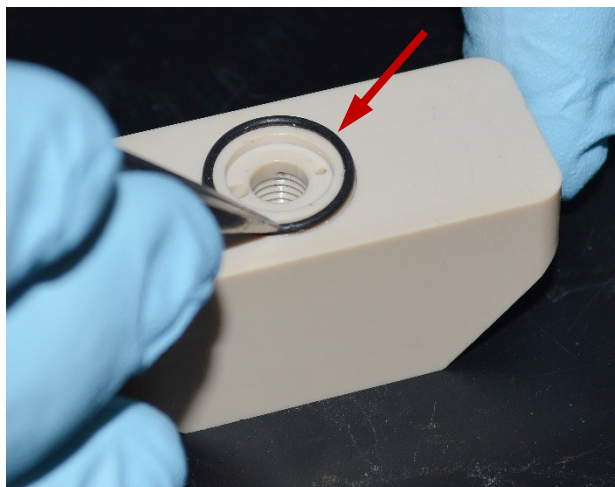

- b. Insert the platinum tube into the plastic fitting.

Cell Connections



If you wish, you may also connect the plastic tubing to the Pt-tube, or you may wait until the plastic fitting is mounted onto the main block.

Carefully slide the static cell into the receptacle of the main block.

- c. Slide the platinum tube plus plastic fitting into port on flow cell.

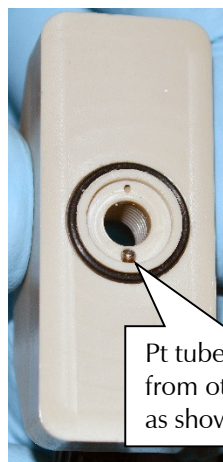
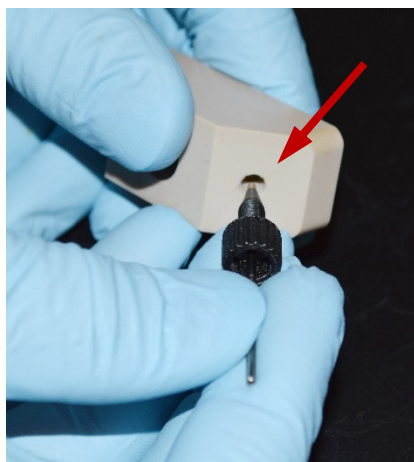

- d. Insert PTFE tube into other fitting.

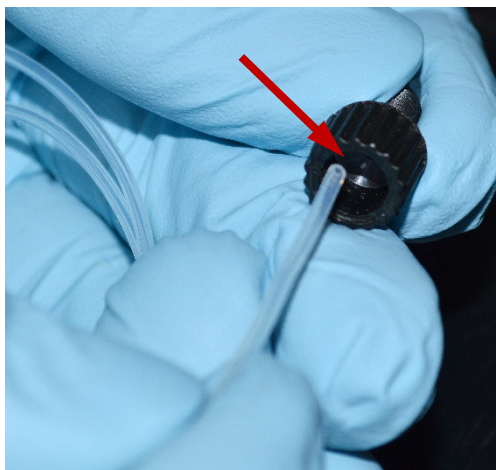

- e. Insert PTFE tube plus fitting into other port on flow cell.

Cell Connections

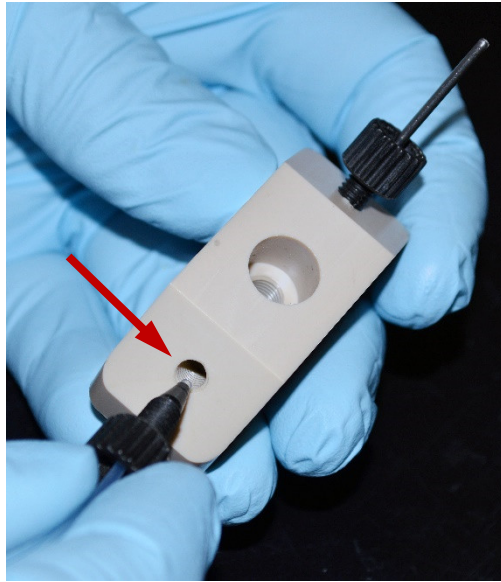

- f. Slide flow cell into main block.

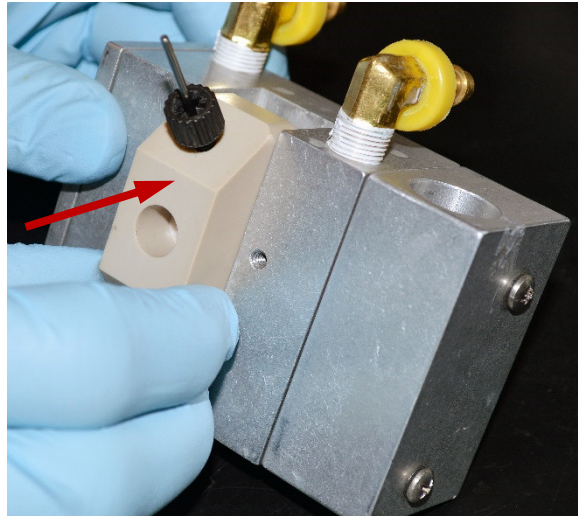

- g. With two thumbscrews, affix capture plate to main block.

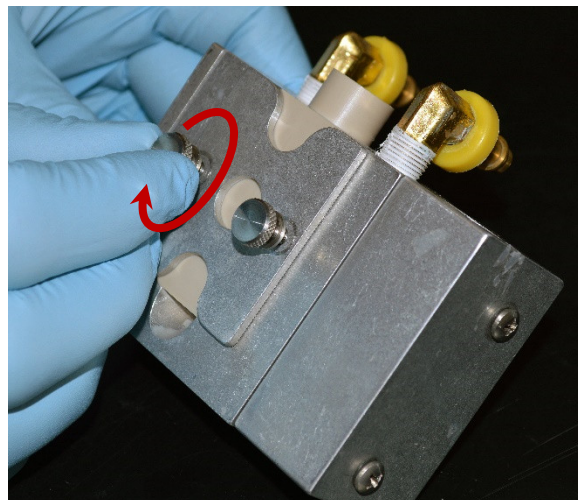

Cell Connections

- h. Insert the plastic plug or the screw-type reference electrode into the flow module.

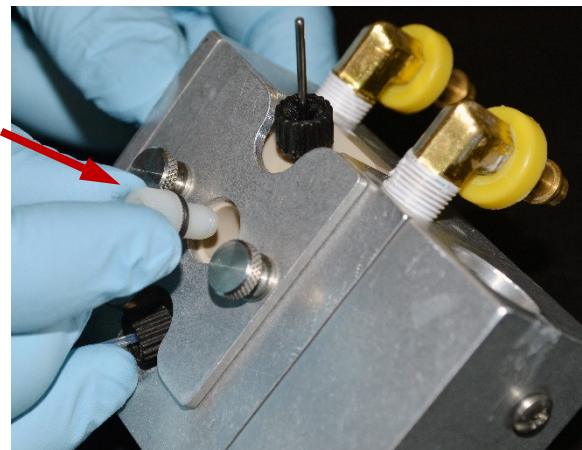

For typical QCM flow systems, insert the reference-electrode plug and seal it with an Allen key as shown here.

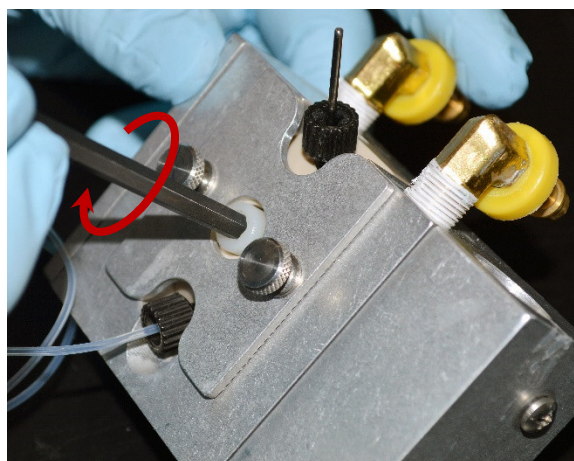

For eQCM flow systems, insert the connection to a peristaltic pump. The connection is a very snug fit.

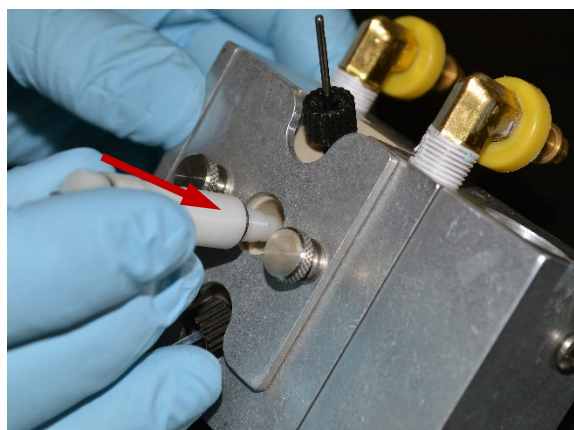

- i. Carefully slide the plastic tubing onto the platinum tube. This can be a very snug fit.

Cell Connections

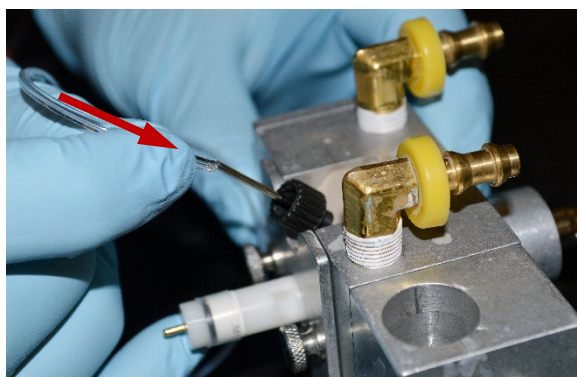

You may also connect the plastic tubing to the Pt-tube before the assembly is mounted onto the main block (see step 10b).

11. Test again if the quartz crystal is mounted properly as shown in step 8. If it is not, you must remove and readjust the quartz crystal.
12. Start any optional temperature-control system and optional flow system. Run your experiment.

Figure 5-2
Connection of Working (Green) and Working Sense (Blue) Leads to eQCM 15M



The eQCM 15M has two 2 mm banana connectors on the front side to connect a potentiostat to the quartz crystal. This allows you to perform EQCM experiments where the quartz crystal additionally serves as working electrode.

Plug the green working electrode lead of the potentiostat's cell cable into the **W.E.** jack (see Figure 5-2). Connect the blue working sense lead of your potentiostat's cell cable to the **W.S.** jack.

A binding post on the rear panel of the eQCM 15M is provided for grounding purposes. A water pipe can be a suitable source of earth ground, or an AC mains ground is also suitable.



Warning: Make sure that you make your earth-ground connection to a legitimate source of earth ground. Consult a qualified electrician if you are uncertain how to obtain an earth ground. Connecting the eQCM 15M to an incorrect and unsafe voltage can create a safety hazard (see Chapter 1 for details).

Environmental Considerations

The eQCM 15M is a very sensitive instrument capable of measuring ng/cm^2 of material deposited onto the electrode face. Therefore, special consideration of the environment will help ensure you are acquiring the best data possible. Minimize or eliminate vibrations or sudden movements during data-acquisition.

Likewise, keep temperature fluctuations to a minimum. Changes in temperature and the rate of change of temperature both cause frequency-drift during data-acquisition. If you are planning very long experiments, a temperature-controlled chamber may be necessary to reduce drift. Leaving the crystal holder in solution for some period of time prior to starting your experiment will help reduce unwanted frequency changes.

Chapter 6: Panel Indicators and Connectors

Front Panel

The eQCM 15M front panel includes two connectors and two backlit LED indicators. Each of these are discussed in turn.



Quartz Connector

The **Quartz** connector is a male BNC-type connector that is used to connect the eQCM 15M to a quartz crystal test cell. Your eQCM 15M system includes a BNC cell cable (P/N 985-00124).

Working Electrode Connectors

The front panel has two 2 mm banana connectors which can be connected to a potentiostat's cell cable. This allows performing EQCM experiments where the quartz crystal additionally serves as working electrode. The **W.E. jack** is hereby connected to the green Working Electrode lead of the potentiostat's cell cable and the **W.S. jack** is connected to the blue Working Sense lead.

The eQCM 15M system also includes two 2 mm pin to 4 mm banana socket cables to accommodate different cable lead connectors.

Power LED

The **Power** LED normally glows a steady blue when the eQCM 15M is turned on. It is off when:

- The **Power** switch is off.
- USB cable is not inserted or connected to a computer, or the computer not powered up.

USB LED

The **USB** LED is a green LED that blinks continuously during data-acquisition. Higher data-acquisition rates may make the LED appear lighted continuously.

Rear Panel

The rear panel contains two connectors.

The QR-code label on the rear panel gives you a link to the eQCM 15M page on Gamry's website.



USB Port

The **USB** port on the rear panel of the eQCM 15M is a Type C connector. This connection is used to power the instrument as well as for all the data transfer between the eQCM 15M and your host computer.

A shielded, Type A/C cable is used to connect this port to a computer's USB port or a USB hub (preferably an externally powered hub). The two ends of a Type A/C cable are different. The more-rectangular, larger end plugs into the computer and the smaller connector plugs into the instrument.

The eQCM 15M requires a minimum of 5 volts through the USB connector. The input current is less than 1 A.

A suitable cable was shipped with your instrument. If this cable is lost, you can get a replacement at Gamry Instruments. Contact your local Gamry Representative or e-mail to techsupport@gamry.com if you experience problems with your USB-cable.

The eQCM 15M is a High Speed USB 2.0 peripheral, capable of data transfer at 480 Mbits/second. If it is plugged into a computer port incapable of High Speed operation it downgrades to USB 1.1 full-speed operation (12 Mbits/second). Obviously, data-transfer speed is slower if this occurs.

The eQCM 15M **USB** port is compatible with Revision 1.1 and 2.0 of the USB specification. It supports the Windows Plug and Play mechanism, including dynamic connect/reconnect.

The QR-code label on the rear panel gives you a direct link to the eQCM 15M page on Gamry's website.

GND

The rear panel **GND** connector is intended for one use only, as a chassis ground. See Chapter 1 for safety information concerning this connection. A black banana-plug to banana-plug lead has been provided with your eQCM 15M. You may find it useful when making this earth-ground connection.

Appendix A: eQCM 15M Specifications

All specifications are subject to change without notice.

Frequency Characteristics

Range	1 – 15	MHz
Resolution	0.02	Hz

General

Power	Max	3	W
Dimensions	Max	175 x 115 x 80	mm
Weight	Max	0.45	kg

Environmental

Operating temperature range		0 to 45	°C
Relative humidity	Max	90 (non-condensing)	%
Storage and shipping temperature		-25 to 75	°C
Maximum shipping acceleration		30	G

Appendix B: Certifications



Declaration of Conformity: No. DOC-2023-CE-eQCM15M

According to ISO/IEC Guide 22 and CEN/CENELEC EN 45014

Manufacturer's Name and Location:

Gamry Instruments
 734 Louis Drive
 Warminster, PA 18974
 USA

This declaration is for the Gamry Instruments product model: eQCM 15M Quartz Crystal Microbalance
 The declaration is based upon compliance with the following directives:

- EU Council Directive 2014/30/EU
- FCC Part 15, Class B

The declaration is based upon product compliance with the following standards as defined in report number 988-00092 REV A 2023 from Gamry Instruments, Inc. for EMC test and analysis.

EMC Standards	Title	Class/ Criteria
EN 61326-1: 2013	Electrical Equipment for measurement, control and laboratory use – EMC requirements – Part 1: General requirements.	
CISPR 11	Radiated Emissions 30 MHz to 1 GHz. Limit: Group 1	
IEC 61000-4-2	Radiated Immunity (EM Field) Level: 3 V/M, 80 to 1000 MHz 3 V/M, 1.4 to 2.0 GHz 1 V/M, 2.0 to 2.7 GHz	
IEC 61000-4-3	Electrostatic Discharge Level: 4 kV Contact, 8 kV Air Discharges	

Signature

June 5, 2023

Date

Dr. Gregory A. Martinchek, PhD
 Title: President

Formal signed declaration is on file at Gamry, Inc.

Certificate of Conformance



Test report

Test Report No.: 070-00001A_2023

Issuer: Gamry Instruments, Inc.
734 Louis Drive
Warminster, PA, 18974
USA

This test report is for the Gamry Instruments product model eQCM 15M (Gamry P/N 990-00517). All instrument parameters are listed in the eQCM 15M Operator's Manual (Gamry P/N 988-00089).

The test is based upon compliance with the following directives:

- EU Council Directive 2014/30/EU
- FCC Part 15, Class B

The table below list a brief description of test methods performed on the eQCM 15M and their results:

EMC Standards	Title	Results
EN 61326-1: 2013	Electrical Equipment for measurement, control and laboratory use – EMC requirements – Part 1: General requirements.	Complied
CISPR 11	Radiated Emissions 30 MHz to 1 GHz. Limit: Group 1	Complied
IEC 61000-4-2	Radiated Immunity (EM Field) Level: 3 V/M, 80 to 1000 MHz 3 V/M, 1.4 to 2.0 GHz 1 V/M, 2.0 to 2.7 GHz	Complied
IEC 61000-4-3	Electrostatic Discharge Level: 4 kV Contact, 8 kV Air Discharges	Complied

Signature

May 24, 2023
Date

Dr. Gregory A. Martinchek, PhD
Title: President

Formal signed report is on file at Gamry, Inc.



Gamry Instruments, Inc.
734 Louis Drive
Warminster, PA, 18974
USA

Phone: +1 215-682-9330
Fax: +215-682-9331
Internet: <https://www.gamry.com/>



Declaration of Conformity: No. DOC-2023-UKCA-eQCM15M

According to ISO/IEC Guide 22 and CEN/CENELEC EN 45014

Manufacturer's Name and Location:

Gamry Instruments
 734 Louis Drive
 Warminster, PA 18974
 USA

This declaration is for the Gamry Instruments product model: eQCM 15M Quartz Crystal Microbalance
 The declaration is based upon compliance with the following directives:

- EU Council Directive 2014/30/EU
- FCC Part 15, Class B

The declaration is based upon product compliance with the following standards as defined in report number 988-00092 REV A 2023 from Gamry Instruments, Inc. for EMC test and analysis.

EMC Standards	Title	Class/ Criteria
EN 61326-1: 2013	Electrical Equipment for measurement, control and laboratory use – EMC requirements – Part 1: General requirements.	
CISPR 11	Radiated Emissions 30 MHz to 1 GHz. Limit: Group 1	
IEC 61000-4-2	Radiated Immunity (EM Field) Level: 3 V/M, 80 to 1000 MHz 3 V/M, 1.4 to 2.0 GHz 1 V/M, 2.0 to 2.7 GHz	
IEC 61000-4-3	Electrostatic Discharge Level: 4 kV Contact, 8 kV Air Discharges	

Signature

June 5, 2023

Date

Dr. Gregory A. Martinchek, PhD
 Title: President

Formal signed declaration is on file at Gamry, Inc.

Appendix C: Comprehensive Index

- CE Compliance, 10
- cell cable, 19
- Chassis Ground binding post, 7
- cleaning, 9
- computer, 11
- computer requirements, 16
- contract engineering, 3
- conventions
 - notational, 11
- crystal holder, 20, 29
- damage, 15
- Declaration of Conformity, 35, 37
- earth ground, 7, 8, 28
- electrical transients, 10
- EMC, 9
- enclosed space, 8
- environmental limits, 9, 33
- environmental stress, 8
- EQCM, 28
- flow cell, 24, 25, 26
- Framework software, 15
- GND** connector, 32
- ground binding post, 8
- Help system, 11
- inspection, 7, 15
- installation, 15
- LED, 31
- operation, 9
- O-ring, 20, 23, 24
- peristaltic pump, 27
- physical location, 15
- platinum tube, 24, 25, 27
- Power** button, 17, 31
- Power Connection, 16, 32
- Power** LED, 17, 18, 31
- power line transient, 10
- PTFE tube, 25
- QR-code, 32
- Quartz** connector, 31
- quartz crystal, 11, 13, 20, 22, 23, 28
- quartz crystal installation, 19
- radio frequency, 9
- reference electrode, 27
- Resonator™ software, 22
- RoHS Compliance, 10
- safety, 7
- schematic, 13
- service, 9
- service contract, 3
- shielding against noise, 8
- shipping, 9
- Single Scan** button, 22
- specifications, 33
- static cell, 23, 24, 25
- static electricity, 10
- storage, 9
- support, 3, 10
- telephone assistance, 3
- temperature, 8
- USB cable, 16
- USB LED, 31
- USB port, 16, 17, 32
- ventilation, 8, 16
- visual inspection, 15
- W.E.** jack, 28, 31
- W.S.** jack, 28, 31
- Warranty, 3
- Windows, 4, 16, 32
- Working Electrode, 28, 31